

# Contents

1	SH-300 Hardware part.....	3
1.1	System General Introduction.....	3
1.2	Specification Parameter.....	3
1.3	Hardware Structure.....	4
1.4	Function Key List.....	7
1.5	Installation Dimensions and Guide.....	8
2	SH300 Software Part.....	11
2.1	SH300 General Introduction.....	11
2.2	Process Chart.....	11
2.3	Installation and Uninstallation of SH-300.....	12
2.3.1	Installation of SH-300.....	12
2.3.2	Uninstallation of SH-300.....	15
2.4	Operation Interface.....	16
2.4.1	File.....	18
2.4.2	Edit.....	18
2.4.3	View.....	19
2.4.4	Screen.....	20
2.4.5	Object.....	21
2.4.6	Connect.....	22
2.4.7	Tool.....	22
2.4.8	Help.....	23
2.5	Operation Instruction.....	24
2.5.1	Indicator.....	24
2.5.2	Function Key.....	25
2.5.3	Static text.....	26
2.5.4	Dynamic text.....	27
2.5.5	Register.....	28
2.5.6	Bar Graph.....	31
2.5.7	Trend Graph.....	32
2.5.8	Bitmap.....	33
2.5.9	Message Display.....	34
2.5.10	Alarm List.....	35
2.6	User-defined SH300 system information.....	37
2.7	Multi Language Editor.....	47
2.8	Operation Example.....	49
3	Manipulation.....	56
3.1	Download Window.....	56
3.2	Communication.....	56
3.3	Shifting the windows.....	57

3.4	System Password.....	57
3.5	Data setting.....	58
3.6	State Monitoring.....	59
4	Connection with PLC.....	61
4.1	Mitsubishi FX Series.....	61
4.2	Siemens S7-200 Series.....	62
4.3	OMRON C Series.....	63
4.4	Delta DVP Series.....	64
4.5	Panasonic FP Series.....	65
4.6	Vigor VH Series.....	66
4.7	Koyo S Series.....	67
4.8	ADC DL05 Series.....	68
4.9	FATEK FBs Series.....	70
4.10	Schneider NEZA/TWIDO Series.....	71
4.11	AB (AB-DF1 Protocol) Series.....	72
4.12	THINGET XC Series.....	73
4.13	Emerson EC20 Series.....	74
4.14	KDN-K3 Series.....	75
4.15	HITACHI MICRO-EH Series.....	76
4.16	MODBUS RTU/ASCII and RTU/ASCII EXTEND protocol.....	77
4.17	SH-300 Freedom Protocol.....	82
4.18	Array FAB Series PLC.....	90
4.19	Array SR Series PLC.....	93
4.20	Array APB Series PLC.....	95
4.21	Array TC-Pro Series Digital Timer/Counter/Tachometer.....	101
	Appendix : Note item.....	103

# SH-300 Hardware part

# 1

## 1.1 System General Introduction

SH-300 is a small Human-Machine interface, mainly being used to be connected with PLC or other intelligent controllers with COM port communication function. It can monitor, setup and modify the data of the register or the status of the relay inside the PLC; thereby manipulators can monitor conveniently the PLC or the running status of the intelligent controllers with COM port communication function.

### [Function features]

- ▲ The project development software SH300, built on WINDOWS platform, with friendly operation interface, easy to learn, being able to edit several monitoring screens and support multi-format graph.
- ▲ The communication protocols will be downloaded into SH-300 Text Display together with the project files. And it is unnecessary to edit the communication program in PLC separately.
- ▲ SH-300 can be connected with many PLC. it supports Mitsubishi, Omron, Siemens, Panasonic ,Delta , Koyo ,Vigor ,ADC Schneider, AB PLC series and so on. it contains Modbus and freedom communication protocol
- ▲ With password protecting function
- ▲ With alarm list function, real-time displaying the alarm information line by line.
- ▲ Having 14 keys, which can be defined as function keys, being easily operated, replacing some mechanical keys on the control cabinet, with the number key function.
- ▲ Supporting several kinds' communication ports: RS232/RS422/RS485
- ▲ STN-LCD with back light display, displaying 24 characters X 4 rows
- ▲ With multi-language displaying function, with user-defined system prompting information, being convenient for different demands.
- ▲ The front panel being up to IP65 Protection Level, waterproof, oil proof

## 1.2 Specification Parameter

### —Hardware specification

Display screen	4.3"STN LCD
Resolution	192 x 64 pixel
LCM life	With 25±2°C, 65±10% RH over 50000 hours

Brightness	60 cd/m <sup>2</sup>
Color	Monochrome(yellow-green)
Contrast	Adjustable resistor
Background light	Long life yellow-green LED
Memory	110KB Flash ROM
Communication Port	PC RS232& PLC RS485/422 & PLC RS232
Function button	14 freely configurable keys
Allowable power disruption	≤20ms
Frame Dimension	171.8 x 84.2 x 38.6mm
Display Dimension	97.0 x 34.5mm
Installation hole Dimension	165 x 85mm
Cooling Method	Natural air cooling
Weight	260g

#### —Electric specification

Rated voltage	12 ~24VDC±10% <300mA
Withstanding voltage test	500V AC 1minute(between signal and GND)
Insulation resistance	Over 10M ohm @ DC500V ( between signal and GND)

#### —Ambient Requirement

Operation ambient temperature	-10℃~60℃
Operation ambient moisture	20~90% (no condensation)
Storage temperature	-20℃~70℃
Anti-jamming test	Voltage 1500Vp-p,pulse period 1us , continuing 1s
Vibration resistance	10~25Hz(2G for 30 min, in any of X,Y,Z axis)
Degree of protection	IP65 (the front panel)



#### Caution!

Pay attention to the two polars of the power and the rated allowable voltage range, otherwise the main machine will be damaged.

## 1.3 Hardware Structure

The front panel of SH-300 is as shown in the following figure. There is the 4.3"STN LCD display at the top left corner. At the top right corner and the bottom there are 20 thin-film switch keys, which have a good handle and a long life. The Up Key, Down Key, ESC key, SET key, ALM key and ENT

key are system keys. Except the basic function, the other fourteen keys can be set as special function keys to realize the Screen-jumping and digital setup functions.

The front of panel of SH-300 programmable text display is shown as follows:

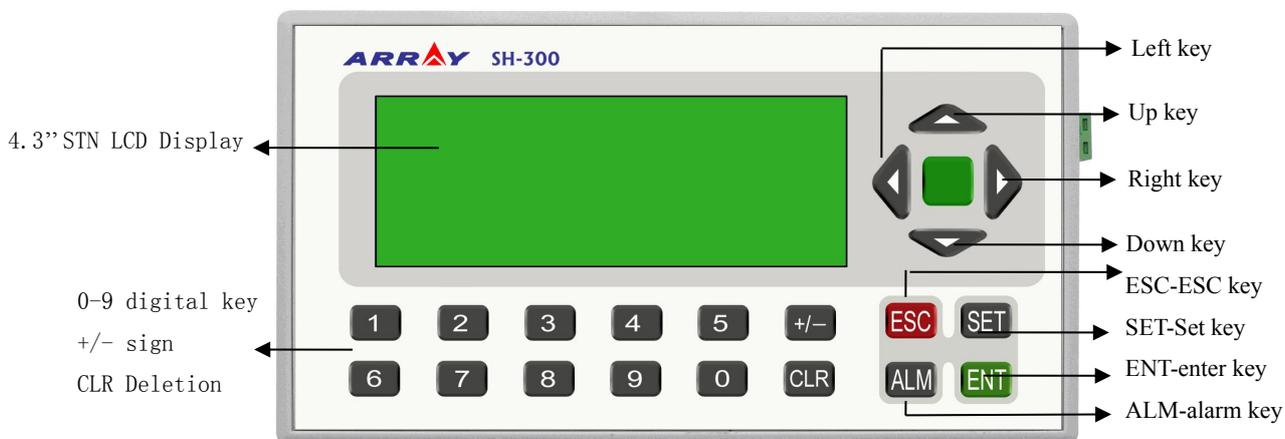

Basic function of keys: setting the input value of the PLC registers.

Special function of keys: Bit setting, Bit resetting and Screen jumping etc.

On the right side of SH-300 there are power terminal and COM port and on the left side there is a contrast potentiometer. Refer to the following figure for details.

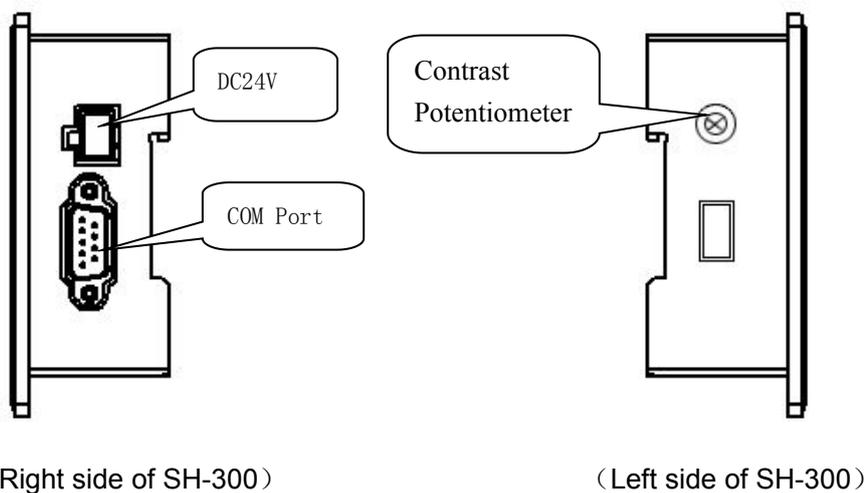

When programming with SH300 software, please select the proper connection mode according to the type of PLC. After completing the edition, connect the SH-300 and the relative serial COM port of the PC via the programming cable SH-Cable. Then power on SH-300 and click the download icon to download the project file into SH-300.

When using if the contrast of the LCD isn't fit, revolve the contrast potentiometer on the left side with small sized screwdriver till the contract reach the desired degree

The display of SH-300 is with LED background light. Press any key, the background light will be turned on automatically. The backlight will be turned off automatically if there is no operation in the minutes .Users can modify the turnoff time of the background light in SH300 software and then download into SH-300. And it will be OK.

**The structure figure of SH-300 COM Port :**

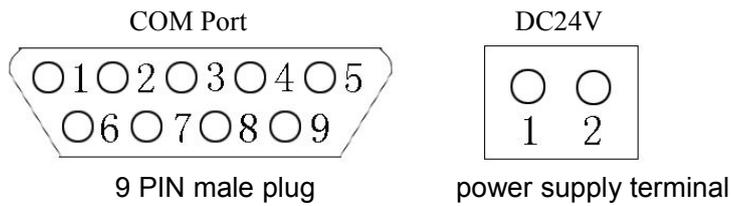

**Pin Definition of SH-300 COM Port :**

Pin	Definition
1	TD+
2	RXD
3	TXD
4	NC
5	GND
6	TD-
7	RTS
8	RD-
9	RD+

**SH-Cable Wiring figure:**

**SH-300 (9 PIN female plug)                      PC (9 PIN female plug)**

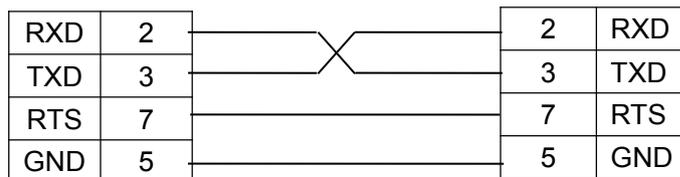

## 1.4 Function Key List

key	Function
[←]	When modifying the register data, the cursor will be moved one-digit left.
[→]	When modifying the register data, the cursor will be moved one-digit right.
[↑]	To jump to the previous screen, whose number is set in the screen property option. (The default value is the current number 1.) In data-setting mode, pressing it, the modified number will be plus 1. The incremental range is 0 to 9 (in decimal system) and 0 to F (in hexadecimal system).
[↓]	To jump to the next screen, whose number is set in the screen property option. (The default value is the current number plus 1.) In data-setting mode, pressing it, the modified number will be minus 1. The incremental range is 9 to 0 (in decimal system) and F to 0 (in hexadecimal system).
[ +/- ]	In data-setting mode, sign of the modified number will be set.
[0-9]	In data-setting mode, the modified number will be set as the corresponding number.
[ESC]	Exit from the current operation such as register set, password input, alarm display and so on.
[ALM]	Pressing this key, you can enter the system-defined alarm information screen.
[SET]	Pressing this key, you can modify the register data. The current modified register will be color-reversely displayed and the current modified digital will be flashing. If there is no register set component in current screen, the operation is the non-operation. If press <b>SET</b> key again before pressing <b>ENT</b> , the current operation will be canceled and you can continue to modify the next register data
[ENT]	In the situation that the password protected function is used, pressing this key, the password set screen will be displayed. In register-setting mode, pressing this key the modified data will be written into the register and then it will continue to modify the next register data. When the last register in this screen is modified, pressing this key, it will exit the register modification state.
[CLR]	In data-setting mode, clear the set data.

## 1.5 Installation Dimensions and Guide

Dimensions of SH-300 (L\*W\*H): 171.8×98.8×38.6 (Unit: mm)

Dimensions of the installation hole: 165×85 (Unit: mm)

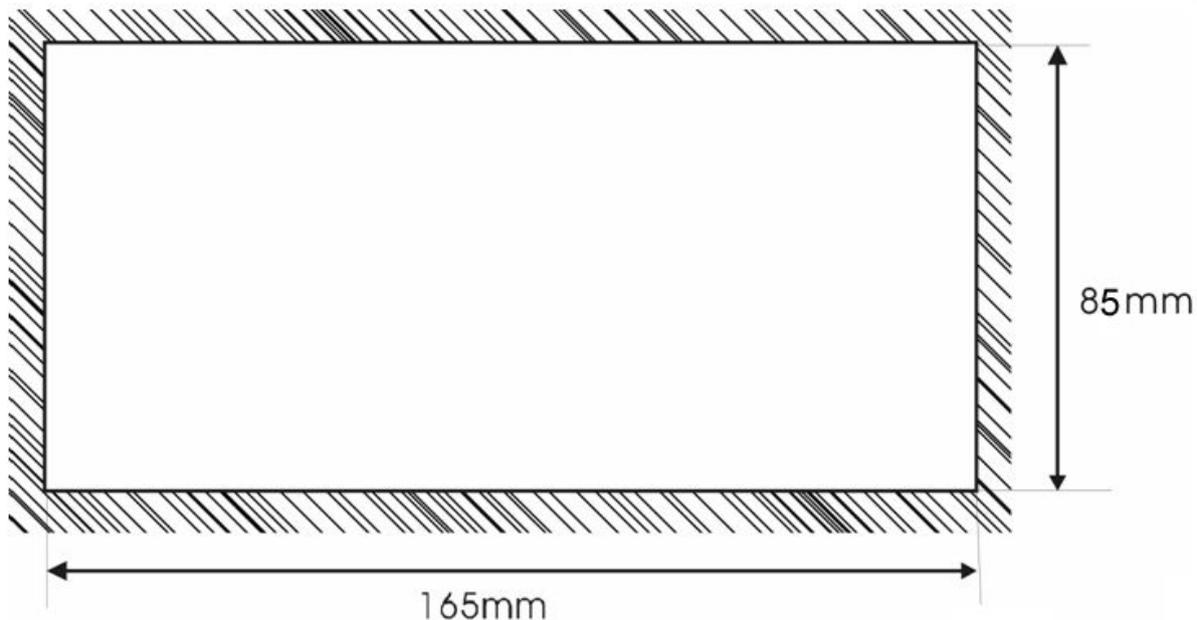

Method 1: Embedded installation

The installment surface must be up to Standard Type 4, being applicable for indoor or the switchboard box on coequal condition.

Thickness of Clapboard: 0.5-0.9 mm. Dimensions of the installation holes are shown as follows:

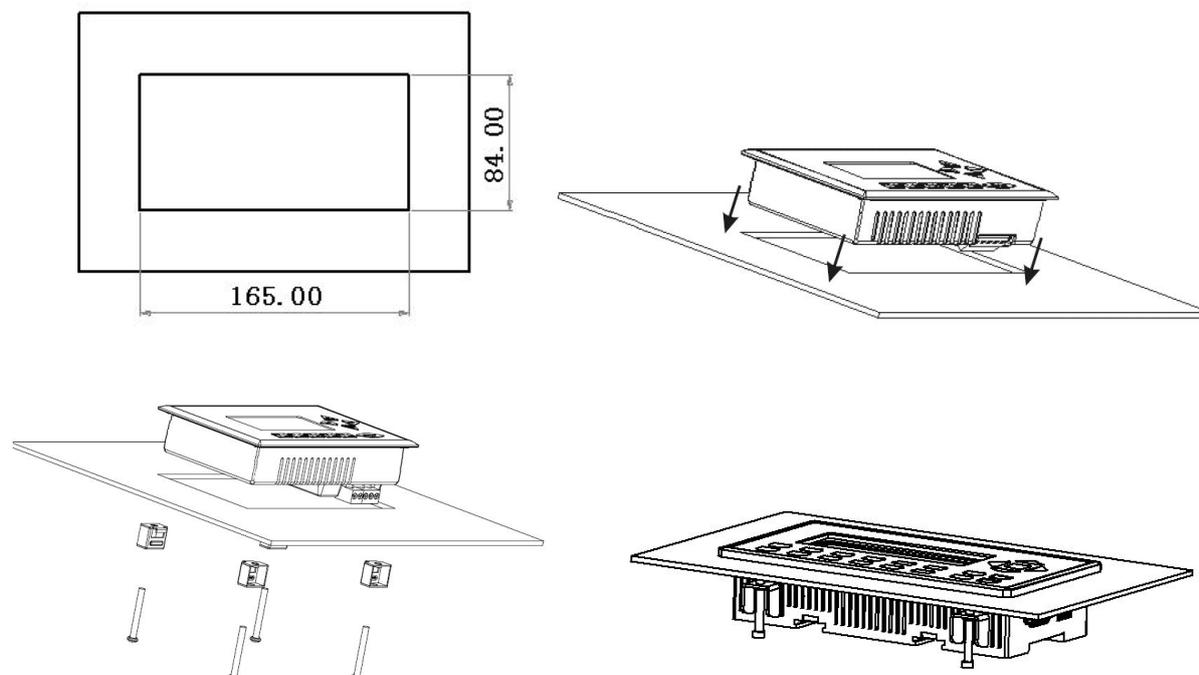



Method 2: DIN rail installation (standard 35mm DIN rail installation)

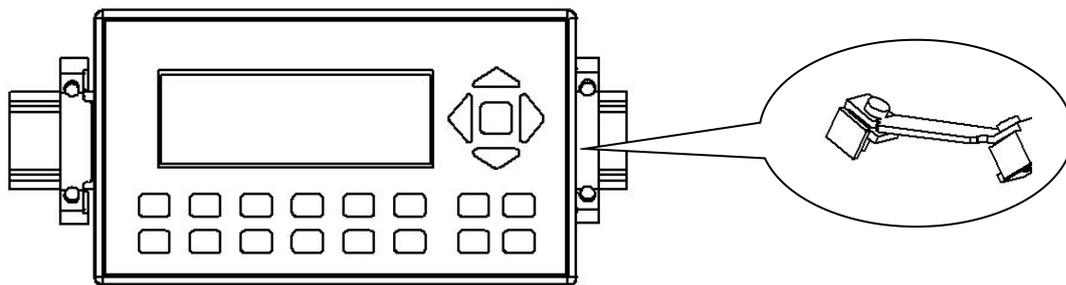

Method 3: Screw installation (To install on the motherboard)

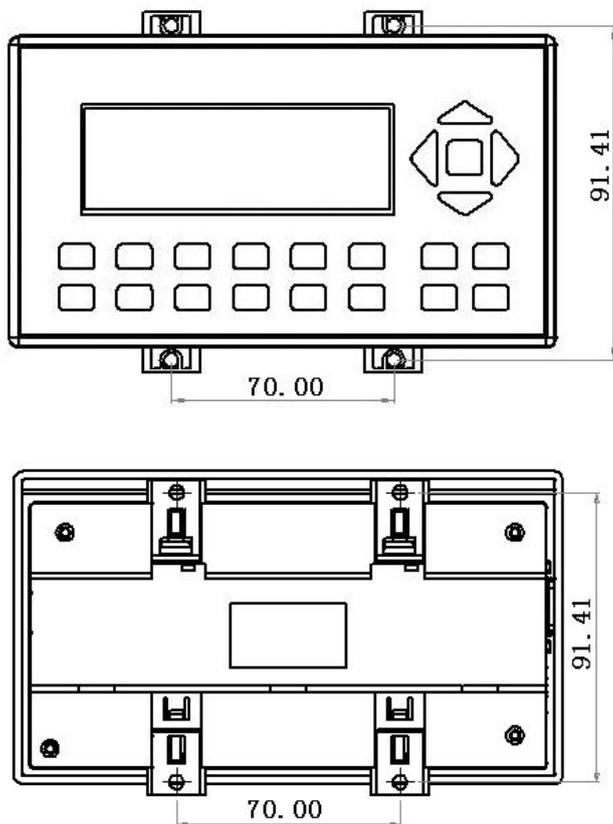



# SH300 Software Part

# 2

## 2.1 SH300 General Introduction

SH300 is the special development software of SH-300 Programmable Text Display, which is run on the base of WINDOWS 98/2000/XP platform. SH300 software makes the best use of the abundant graphic interface and the object-faced design of WINDOWS, which makes it convenient for the users edit the required control screens and the alarm interfaces in a short time.

The essential of the project file is the Screen. Each screen is to perform some special functions and different screens can be switched freely via design. The aggregate composed of all the screens is the application project file.

After open the SH300 software, the user can create or open the screen. And in each screen static text, dynamic text, indicator, register, function key, bit graph, bar graph, trend graph and so on elements can be set. Different screens can be switched freely. Users can realize the data monitor, parameter setup, switch control, alarm list monitor and so on functions by designing the contents of the screen.

## 2.2 Process Chart

The basic process chart of using is shown in the following figure:

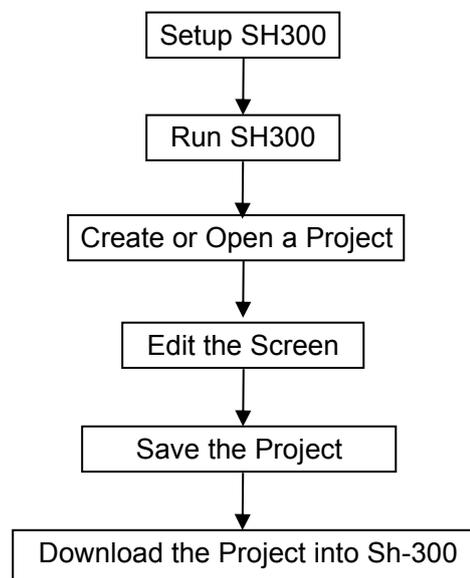

## 2.3 Installation and Uninstallation of SH300

### 2.3.1 Installation of SH300

The installation of SH300 is very simple. In the installation process, a prompting dialogue box will appear automatically and you will complete the installation smoothly on the computer under its guidance. The main steps are as follows:

1. Insert the SH300 software CD into the CD Driver. Select the installation program file **Setup.exe** and click it , the following diagram will be shown:



- ▲ Click **NEXT** to enter the next installation step. The License Agreement will be shown as in the following diagram:

- ▲ Click **Cancel** to exit the installation program.

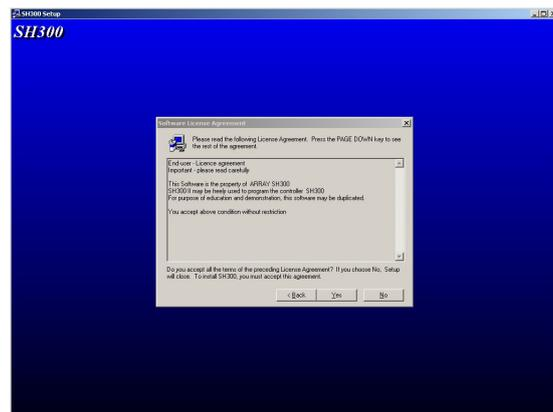

2. If you agree the above license agreement, please click **YES** to enter the next step. The interface requiring User Name, Company Name and Serial Number will be shown as follows:

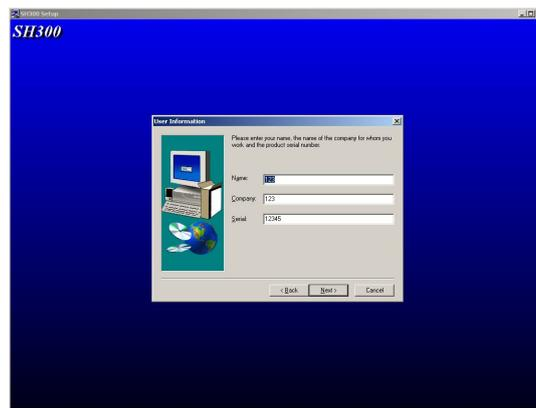

3. Fulfill the interface with the correct information and click **NEXT** to enter the installation path setting interface as follows:

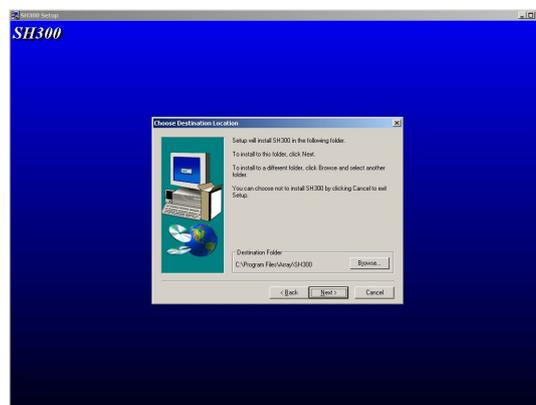

- ▲ Click **NEXT**, the SH300 software will be installed in the default path as shown. If it is necessary to select the path, click BROWSE to reset the desired path.
- ▲ Click **Back**, it will return to the previous interface.
- ▲ Click **Cancel**, it will exit the installation program.

4. Select **NEXT** to enter the next installation window;

- ▲ If **Typical** option is selected, all application components of SH300 will be installed;
- ▲ If **Compact** option is selected, the simplified components of SH300 will be installed;
- ▲ If **Custom** option is selected, user will be allowed to select the components of SH300.

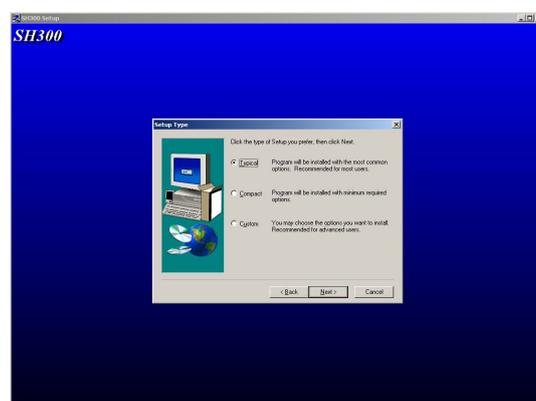



## 2.3.2 Uninstallation of SH300

There are two ways for the uninstallation of SH300:

### 1. Remove from WINDOWS START MENU

- ▲ Under the WINDOWS taskbar, click Start→Program→ARRAY→SH300→Uninstall of SH300  
As shown in the following diagram:

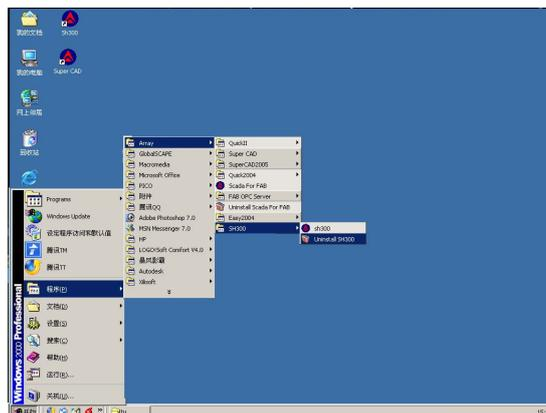

- ▲ When a confirm uninstall dialogue box appearing, click **Yes** and the following remove interface will appear.



### 2. Remove from the Console:

- ▲ Under the WINDOWS interface, double click **My Computer** and the management files of **My Computer** will be open.
- ▲ Double click and open the Control Panel. In the Control Panel, select **Add/Remove Program** icon and the **Add/Remove Program** dialogue box appears.
- ▲ After selecting the SH300 program folder in the said dialogue box, click **Modify/Delete** button and a dialogue box appears to ask if you want to remove the program. Click **Yes** and the remove interface will appear as the above diagram.

## 2.4 Operation Interface

The window of SH300 software is mainly made up of menu bar, tool bar, distribution bar, edit section, window description section, status bar and property section.

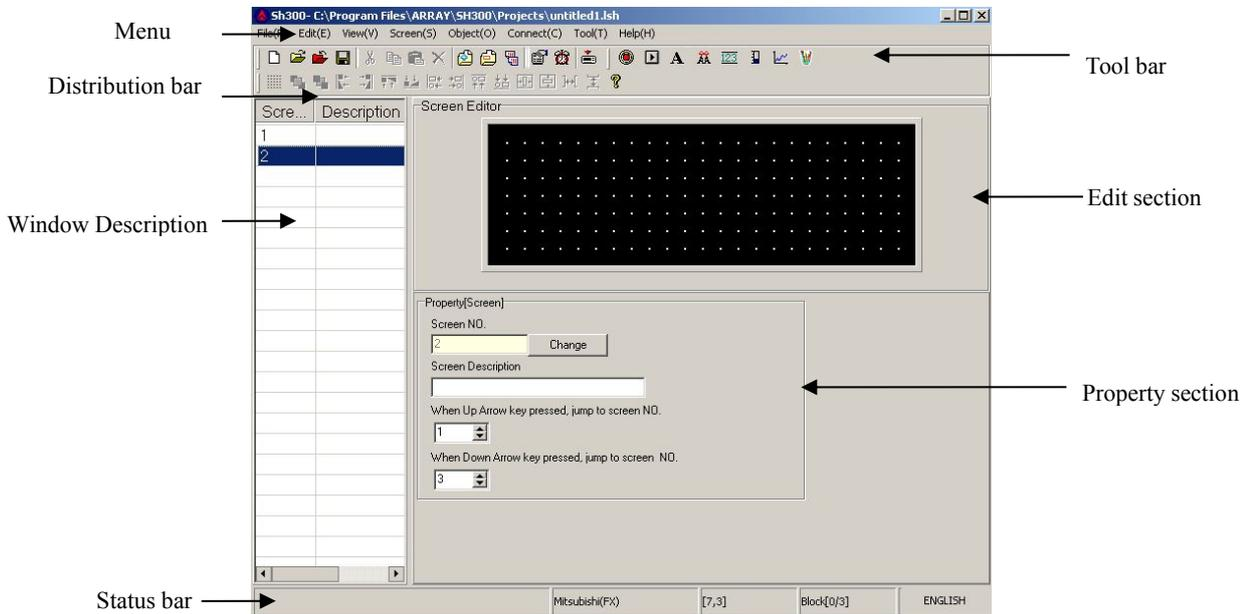

Tool bar	
	Create a new project file
	Open a saved project file
	Close the current project file
	Save the current project file
	Cut components
	Copy components
	Paste components
	Delete components
	Create a new screen
	Delete the current screen
	Copy the current screen
	Set relative parameter of SH-300 Text Display
	Login in alarm list information, each piece of alarm information correspond to a status of a middle relay
	Download the project into SH-300 via communication cable



	Indicator: displaying on/off status of PLC inner middle relay
	Function key: 14 keys on SH-300 panel being able to be defined as function keys, whose functions are screen-jumping and switch control etc.
	Static text, including Chinese characters, English characters and characters from other operation system
	Dynamic text, text content being able to be changed by PLC's register.
	Register, placing the data-setting and data-setting components (The operated object is the data register in PLC.)
	Bar graph, which can be used to monitor data change in PLC
	Trend graph, which can be used to monitor data change in PLC
	Insert the monochrome graphics file (Max. 192×64 pixels )
	Message display, which can display the status of PLC inner relay user-definedly.

Distribution bar	
	Place on the above layer
	Place on the next layer
	Left align all selected objects
	Right align all selected objects
	Up align all selected objects
	Down align all selected objects
	Left frame align all selected objects
	Right frame align all selected objects
	Up frame align all selected objects
	Down frame align all selected objects
	Align in the middle horizon all selected objects
	Align in the middle vertical all selected objects
	Align in the horizontal equal interval all selected objects
	Align in the vertical equal interval all selected objects

## 2.4.1 File

This instruction is mainly used for project file management, including creating, opening, saving etc

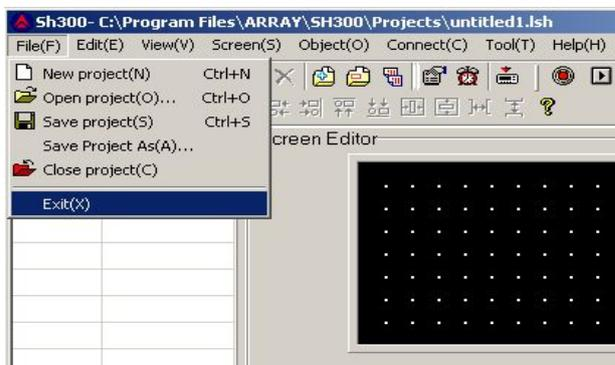

Menu Name	Function
New project	Create a new project file
Open project	Open an old project file
Save project	Save the current project file
Save as	Save the current file to a new path
Close project	Close the current project file
Exit	Exit SH300 software

## 2.4.2 Edit

This instruction is mainly used for tool management, including cut, copy, paste, delete, select all, control, position and so on. The pulldown menu is shown as the following:

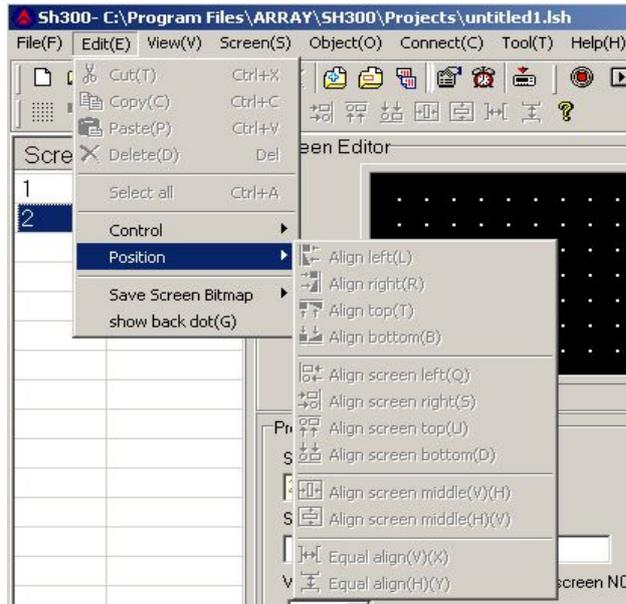

Menu Name	Function
Cut	Cut components
Copy	Copy components
Paste	Paste components
Delete	Delete components
Select All	Select all components
Control	Change the arrangement
Position	Set alignment type
Save Screen Bitmap	Save the current screen as graph format
Show Back Dot (G)	Display

### 2.4.3 View

This instruction is to display the toolbar, distribution bar and the status bar. The pulldown menu is shown as the following:

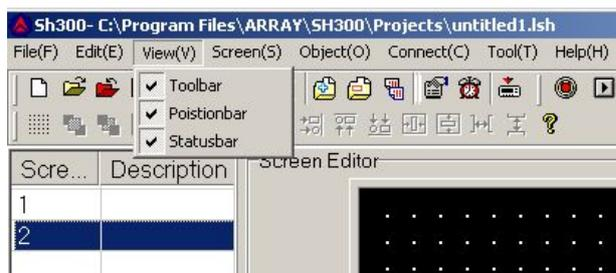

▲ Toolbar: Toolbar displaying instruction

- ▲ Positionbar: Distribution bar displaying instruction
- ▲ Statusbar: Status bar displaying instruction

## 2.4.4 Screen

This instruction mainly includes new screen, delete screen, copy screen, set screen No., SH300 config and alarm list.

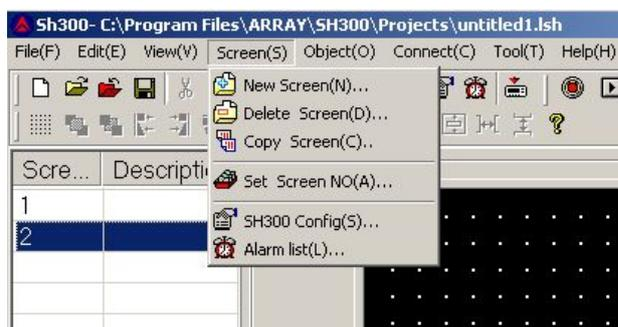

Menu Name	Function
New screen	Create a new screen
Delete screen	Delete the current screen
Copy screen	Copy the current screen
Set screen No.	Reset the screen number
SH300 Config	Set relative parameter of SH-300
Alarm list	Login the alarm list information; each piece of the information corresponds to a status of a middle relay

The “SH300 Config(S)...” option is used to set relative parameter of SH-300, such as set the boot screen number (the default screen number is 1.), password protection (the password will be number from 0 to 99999.) and screen save.

### Screen Save

The duration time of the background light can be set freely.

When “Never” is selected, the background light will be on all the time;

When “After 3 minute ” is selected, the background light will be off 3 minutes later, if there is no operation on the key.

**Notes:** Pressing on any key will wake up the screen background light.

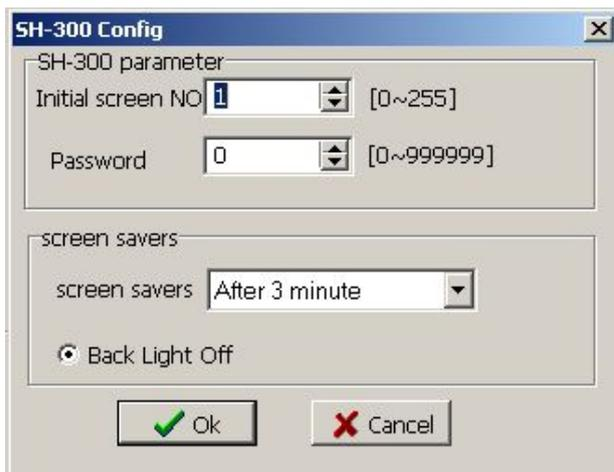

**Caution!**

The maximal number of the screen is 256.

### 2.4.5 Object

The instruction mainly includes Lamp, Touch Key, Static Text, Dynamic Text, Numeric, Process Bar, Trend Line, Picture and Message Display.

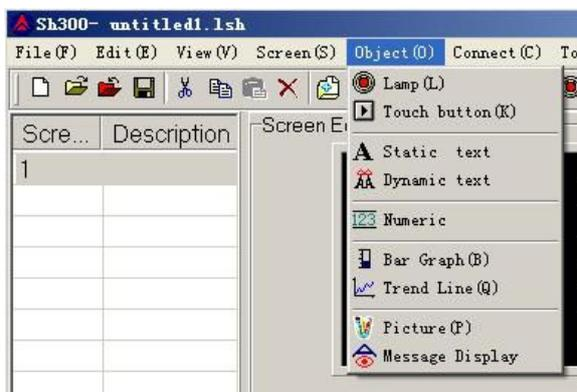

Menu Name	Function
Lamp	Displaying on/off status of PLC inner middle relay
Touch button	14 keys defined as function keys, which being used to realize the screen-jumping, switch control and so on functions.
Static text	Including Chinese characters, English characters and characters from other system
Dynamic text	Text contents can be controlled and changed by PLC register
Numeric	Register, placing the data-setting and data-setting components (The operated object is the data register in PLC.)

Progress Bar	Bar graph, which can be used to monitor data change in PLC
Trend Line	Trend graph, which can be used to monitor data change in PLC
Picture	Insert the monochrome graphics file (Max. 192×64 pixels )
Message Display	Displays the status of PLC inner relay user-definedly.

## 2.4.6 Connect

The instruction is mainly used to Set PLC type, Set Communication Port and Download Data.

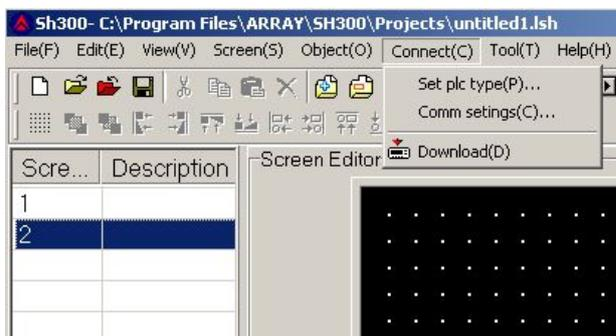

- ▲ Set PLC type: setting the linked PLC type and parameter
- ▲ Comm Setting: selecting the communication port
- ▲ Download: download the project data file into SH-300

## 2.4.7 Tool

The instruction is mainly used for password protection and user-defined information including protect file password and immanent resource

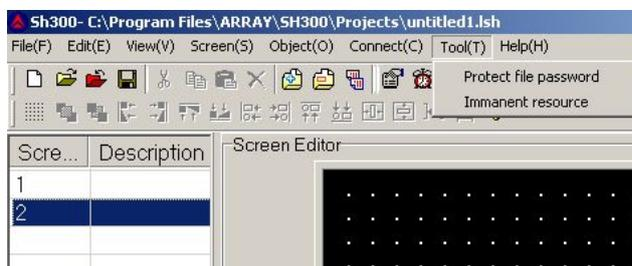

- ▲ Protect File Password: Set the SH300 project file to be password protected.



- ▲ User-defined Immanent resource: to re-define the relative information of each interface in SH-300.

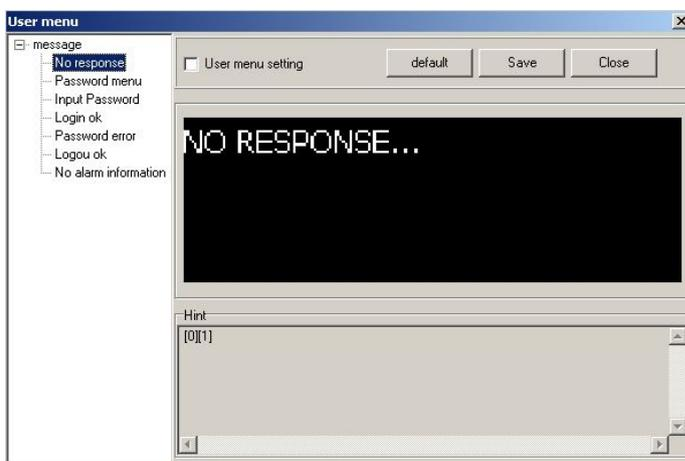

## 2.4.8 Help

The menu mainly includes SH300 software version No. and other information.

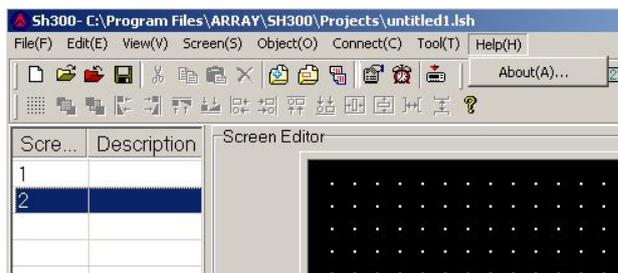

## 2.5 Operation Instruction (Mitsubishi FX Series as an example)

### 2.5.1 Indicator

Click “Lamp” option under “Object” menu or click  in toolbar, there will be a dashed rectangular frame following and moving together with the mouse. Move the mouse to the proper position in the edit section and then click the left button of the mouse to confirm, and there will be one indicator in the edit section.

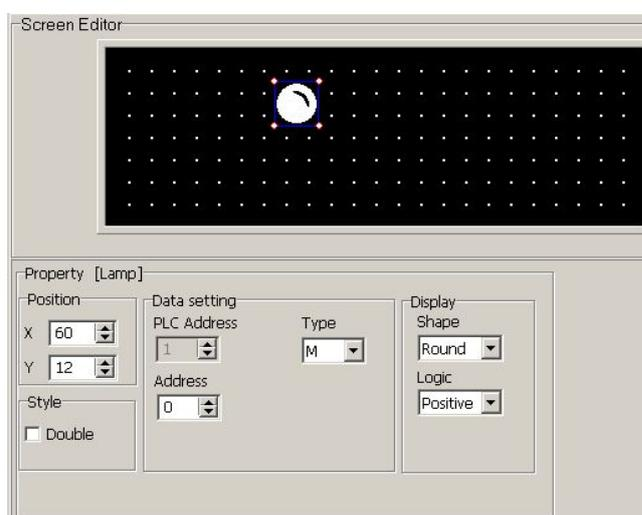

▲ Position Property:

X Position: specifying the horizontal position of the component

Y Position: specifying the vertical position of the component

Note: The grid origin is at the top left corner of the screen.

▲ Data Setting:

The number, type and address correspond to the definition of PLC inner relay.

▲ Style: Double:

The displaying picture of the indicator will be double.

▲ Display:

There are two shapes of the indicator: round and square.

There are two modes of the logic: positive and negative

Logic Choice	State	Displaying Picture
Positive Logic	1	



Positive Logic	0	
Negative Logic	1	
Negative Logic	0	

In positive logic, if the corresponding middle relay is ON, the indicator will be solid; and if the corresponding middle relay is OFF, the indicator will be hollow.

In negative logic, if the corresponding middle relay is ON, the indicator will be hollow; and if the corresponding middle relay is OFF, the indicator will be solid.

## 2.5.2 Function Key

Click “Function Key” option under “Object” menu, or click  in toolbar, there will be a dashed rectangular frame following and moving together with the mouse. Move the mouse to the proper position in the edit section and then click the left button of the mouse to confirm, and there will be one indicator in the edit section.

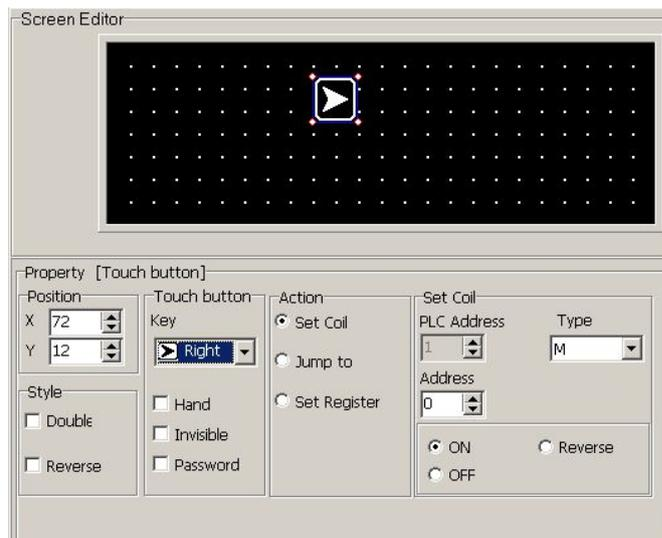

### ▲ Position Property:

X Position: specifying the horizontal position of the component

Y Position: specifying the vertical position of the component

Note: The grid origin is at the top left corner of the screen.

### ▲ Function key Property

Key: to select any proper key from Left .Right.+/-CLR. 0-9 14 keys

Hand: to add a hand shape symbol before the selected key, which indicates that pressing the key will carry out an operation for the convenience of use.

Invisible: to hide the key

Password: The function key will be effective, only when the password is entered correctly.

Coil Set: Action of the function key is defined as digit setup function.

Screen-Jumping: Action of the key is defined as screen-jumping function.

Register Set: Action of the key is defined as register parameter setup function.

▲ Coil

The number, type and address correspond to the definition of PLC inner relay.

ON: to set the designated relay to be ON.

OFF: to set the designated relay to be OFF.

Reverse: Press this key, the value of the designated relay will be reversed.

▲ Style

Double: The displaying picture of the indicator will be double.

Reverse: The function and the background color will be reversely displayed.

## 2.5.3 Static text

Click “Static Text” option once with left button of mouse of menu “Object”, or click  once in toolbar, there will be a dashed rectangular frame following and moving together with the mouse. Move the mouse to the proper position in the edit section and then click once the left button of the mouse to confirm, and there will be one indicator in the edit section.

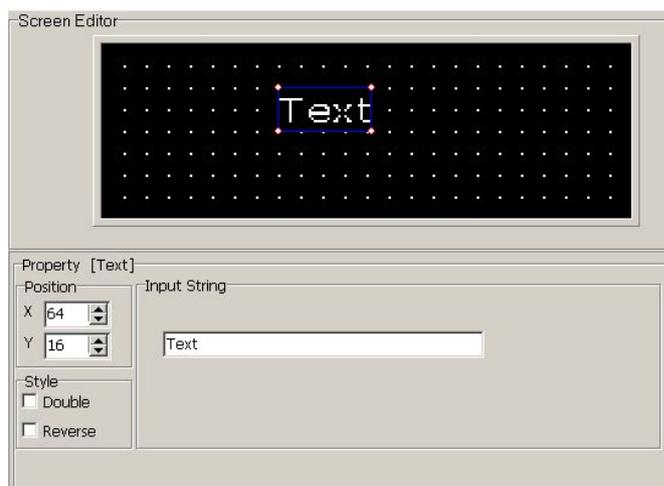

▲ Position Property:

X Position: specifying the horizontal position of the component

Y Position: specifying the vertical position of the component

Note: The grid origin is at the top left corner of the screen.

▲ Input String:

To input relevant text explanation, which can be input 24 English characters\*4 rows or 12 Chinese characters\*4 rows

▲ Style

Double: The static textbox will be double relatively.

Reverse: The static textbox and the background color will be reversely displayed.





If the value of D100 is 60, the “motor speed is normal” will be displayed as follows:



If the value of D100 is 80, the “motor speed is too rapid” will be displayed as follows:



## 2.5.5 Register

Click “Register” option under “Object” menu, or click  in toolbar, there will be a dashed rectangular frame following and moving together with the mouse. Move the mouse to the proper position in the edit section and then click the left button of the mouse to confirm, and there will be one indicator in the edit section.

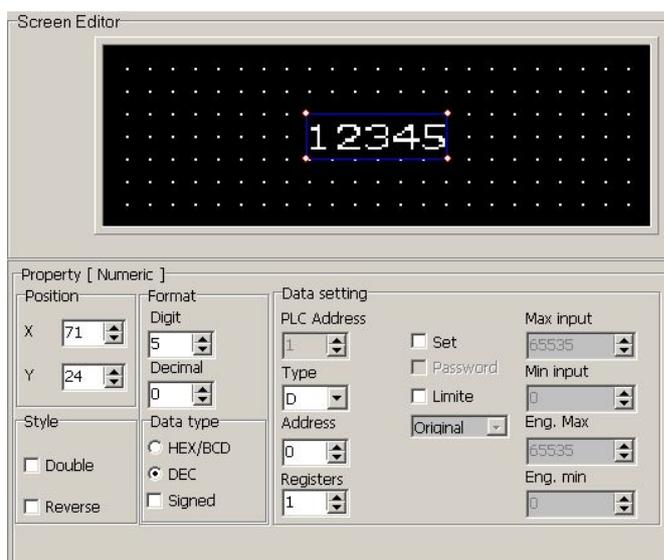

▲ Position Property:

X Position: specifying the horizontal position of the component

Y Position: specifying the vertical position of the component

Note: The grid origin is at the top left corner of the screen.

▲ Style

Double: The register will be double relatively.

Reverse: The register and the background color will be reversely displayed.

▲ Format

Set the digits, decimal digits and the display mode of the register data. The display mode has 3 options, HEX/BCD, Decimal system and symbol.

▲ Register

To set the type and address of the related PLC register. The "Type" is the corresponding PLC register type connected to the PLC. The "Address" is the corresponding PLC address connected to the PLC. The "Mode" has 3 options, HEX/BCD, Decimal system and symbol, which is to control the data format of the data register and will influence the displaying format of the value in the displaying text.

### SET

If cross the "Set" check box, the "Password" option will be displayed. When the "Password" option is selected, if user wants to set the value via "SET" key on the SH-300 panel, it is needed to press "ENT" key to enter the password interface and input the correct password.

### Limit

To set the upper and lower limit, make the value beyond the limit invalid and avoid the input of too large or too tiny value to endanger the system.

**Example:** If the set upper limit is 800, and the set lower limit is 100. Only when the set value is between 100 and 800, the set value will be written into the PLC. Otherwise it will wait to set the new valid value.

After "Limit" is selected, users can select "**Original Data**" or "**Engineering Limits**".

#### Original data:

**Original Data** means the directly displaying register value without any operation. And the radix point will be placed according to the decimal digits. If the decimal digits are 2 and the register value is 24561, the displayed data will be 245.61.

#### Engineering Limits

The maximum and minimum of the project data

#### Project data

This option means that the data read from the register will be converted to project data before being displayed. The conversion is done following the formula below:

The converted data =  $\text{project Min} + (\text{original value} - \text{input Min}) \times (\text{project Max} - \text{project Min}) / (\text{input Max} - \text{input Min})$

Example: the data value stored in the register is 1000, do the setting as follows:

Max Input: 4000

Min Input: 0

Max Project: 2000

Min Project: -2000

Then by conversion the project data =  $-2000 + (1000 - 0) \times (2000 - (-2000)) / (4000 - 0) = -1000$

**Caution!**

There may be some error in the conversion because of the limit of the operation precision of the floating number.

For example: Design requirements: Screen 2 is two groups of the main property parameter of the related PLC, the rotate speed of principal axis and the rotate speed of the countershaft. The left column is the set value and the right column is the actual value. And the corresponding relationship of the two groups of parameters and the PLC data register address is as the following table:

Designation	Address for preset value	Address for actual value
Primary Axis Speed	D100	D110
Secondary Axis Speed	D200	D210

The procedure of creating Screen 2 is as below:

Create Screen 2. Then set "Target", "Current", "Primary", "Secondary" in the proper position in the screen as shown in the following:



Select "**Register**" option or click  in the tool bar; move the mouse to the proper position under "Target" and click the left key of the mouse to confirm. Do the settings as below: register address=D100, register number=1, digits=5, decimal=0, mode=Dec, the negative number will not be displayed.

Select "**Set**" check box, and "**Password**" options is enabled, "**Password**" "**Limit**" can be set according to the demands. Set D200 as above data set method.

Select "Register" option or click  in the tool bar; move the mouse to the proper position under "Target" and click the left key of the mouse to confirm. Do the settings as below: register address =D110, register number=1, digit=5, decimal=0, mode=Dec, the negative number will not be displayed. And don't select "Set" check box. Set D210 as above method.

After all parameters are set, the following diagram will be shown:

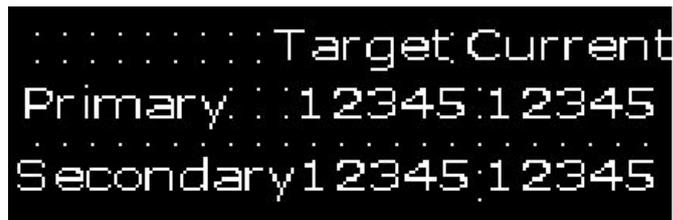

## 2.5.6 Bar Graph

Click “Bar Graph” option under Object” menu,click  in toolbar, there will be a dashed rectangular frame following and moving together with the mouse. Move the mouse to the proper position in the edit section and then click the left button of the mouse to confirm, and there will be one indicator in the edit section.

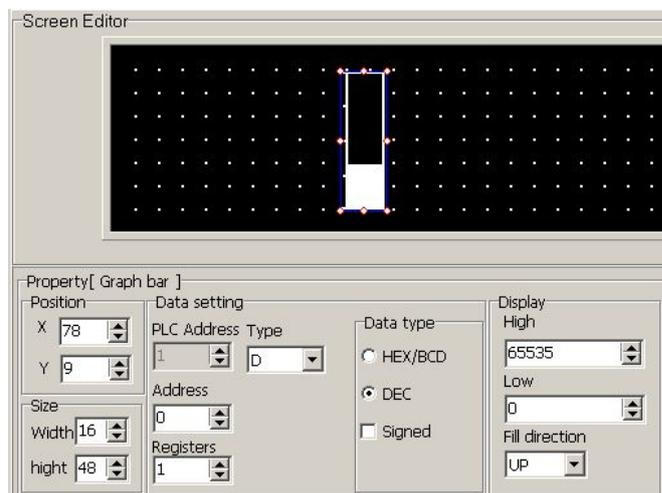

### ▲ Position Property:

X Position: specifying the horizontal position of the component

Y Position: specifying the vertical position of the component

Note: The grid origin is at top left corner of the screen.

### ▲ Register

Set the address, number, type and mode (HEX/BCD, Decimal system and symbol) of the related register.

### ▲ Size

Set the height and width of the bar graph.

### ▲ Display

Full amount: 100% bar graph will display the corresponding register value

Empty amount: 0% bar graph will display the corresponding register value

Direction: the direction of the bar graph includes four options: up, down, left and right.

**Example:** Create a bar graph about precipitation and the display range is 0-100mm. Put the texts “mm”, “precipitation”, “0”, “100” in proper position as shown in the following diagram:

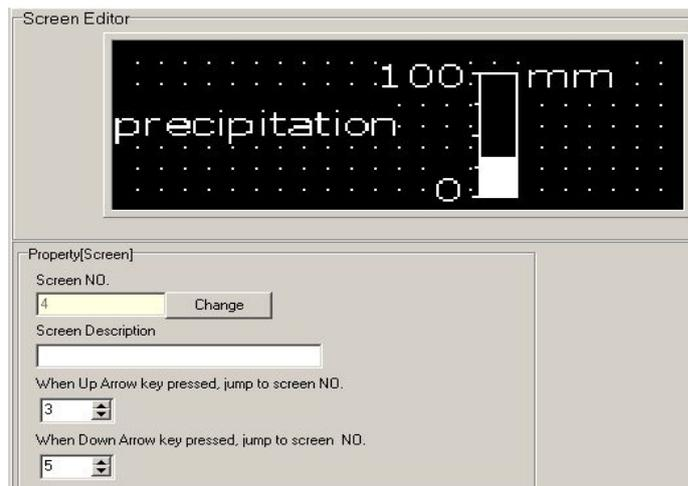

This bar graph can be used to monitor the data in register D0. If the bar graph is fully displayed, it means the value in register D0 is 100. And when the bar graph is 20% displayed, it means the value in register D0 is 20.

## 2.5.7 Trend Graph

Click “Trend Graph” option once with left button of mouse of menu “Object”, or click  once in toolbar, there will be a dashed rectangular frame following and moving together with the mouse. Move the mouse to the proper position in the edit section and then click once the left button of the mouse to confirm, and there will be one indicator in the edit section.

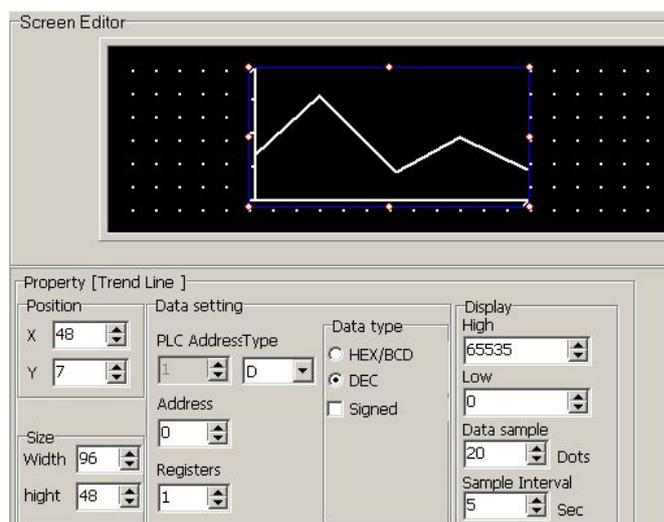

### ▲ Position Property:

X Position: specifying the horizontal position of the component

Y Position: specifying the vertical position of the component

Note: The grid origin is at the top left corner of the screen.

### ▲ Register

Set the address, number, type and mode (HEX/BCD, Decimal system and symbol) of the related register.



▲ Size

Set the height and width of the trend graph.

▲ Display

Full amount: 100% trend line will display the corresponding register value

Empty amount: 0% trend line will display the corresponding register value

Date dots: the total sample number in the whole trend line from left to right. The more the number is, the trend line will be more fine and the time will be longer.

Sample interval: the interval between two neighboring sample dots.



Note: A trend line component can only display one line.

## 2.5.8 Bitmap

Select “**Bitmap**” option under “**Component**” or click  icon in the tool bar, the following prompting frame will be shown:

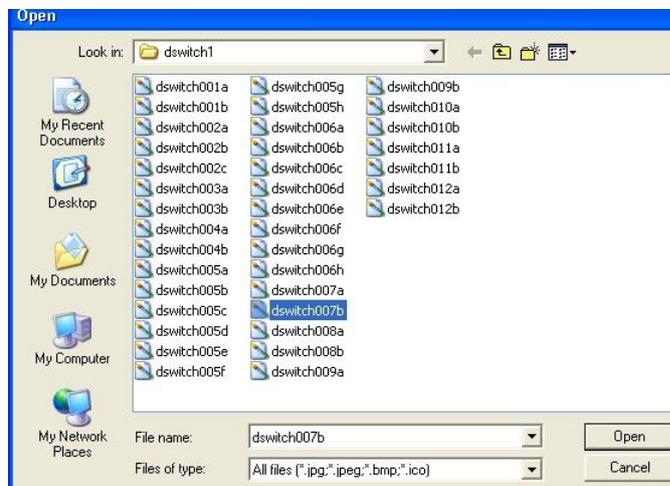

Select your desired picture and then click “**Open**” option. The selected picture will be put in the edit window, as shown in the following diagram:

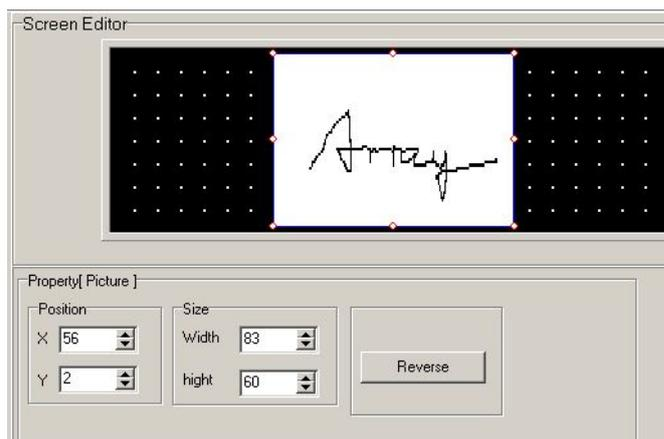

- ▲ Position Property:
  - X Position: specifying the horizontal position of the component
  - Y Position: specifying the vertical position of the component
  - Note: The grid origin is at the top left corner of the screen.
- ▲ Size
  - To adjust the height and width of the bitmap
- ▲ Reverse
  - The color of the picture and the background will be reversely displayed.



Note: SH300 software can support many kinds of graphic files, such as \*BMP, \*ICO, \*JPG etc.

---

## 2.5.9 Message Display

Select “**Message display**” option under “**Component**” or click  icon in the tool bar, the following prompting frame will be shown. Click the left key of the mouse to confirm after moving the mouse cursor to the proper place of edited area.

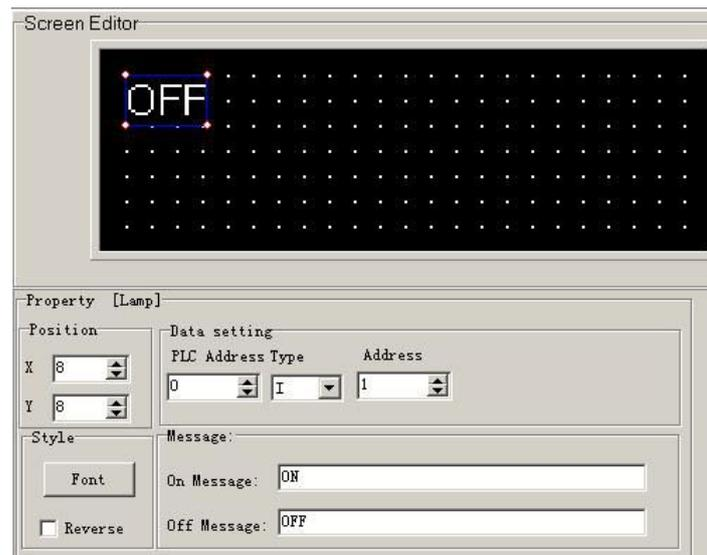

▲ Position Property:

X Position: specifying the horizontal position of the component

Y Position: specifying the vertical position of the component

Note: The grid origin is at the top left corner of the screen.

▲ Coil Property

Station number, type and the address correspond to the type of PLC relay.

▲ Style

Font: the type and size of displayed message are changeable.

Reverse: the background color will be reversely displayed.

▲ Message

On Message: the content is editable, and will be displayed when the coil is ON.

Off Message: the content is editable, and will be displayed when the coil is OFF.

## 2.5.10 Alarm List

Select “**Alarm List**” option under “**Window**” or click  in the tool bar, the following prompting frame will be shown:

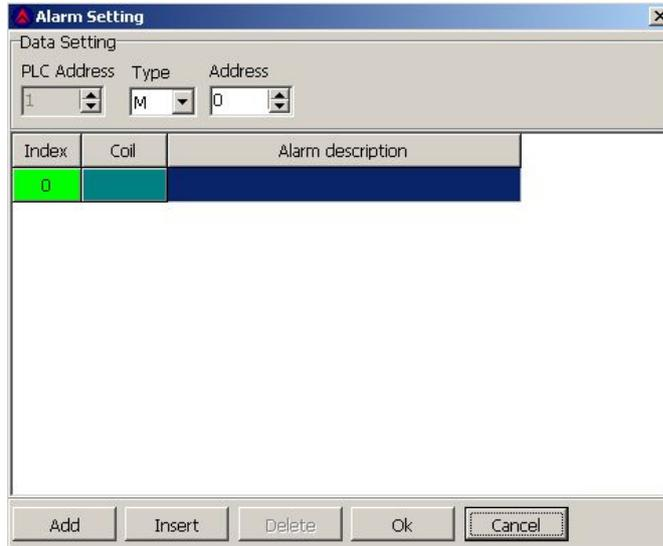

Each project file of SH-300 can set a group of alarm list information. And each piece of information corresponds to a relay. The definition numbers of all the relays are continuous. And the first addresses of all the relays are set by the users according to the actual program. If any relay changing from OFF to ON means the relative alarm is produced, and now the SH-300 will prompt the alarm displaying screen automatically and the alarm information will be displayed in the first row. If another relay is ON now, the new piece of alarm information will be displayed in the second row. On the contrary, if any alarmed relay is OFF, the related alarm information will disappear automatically.

**Example:** Create a group of alarm information about pump. Set Relay M100, M101, M102 and the related alarm information contents are “over 5m for water level”, ”overload for pump”, ”error for power”.

The operation procedures are as the following:

1. Set the first coil type as M, the initial as 100.
2. Input “Water level is over 5m” in the line of the alarm contents bar. Click “**Add**” button or press “**Enter**” key to add the second line and input “Pump overload”. By the same method, add the third line and input “ Power supply fault”.

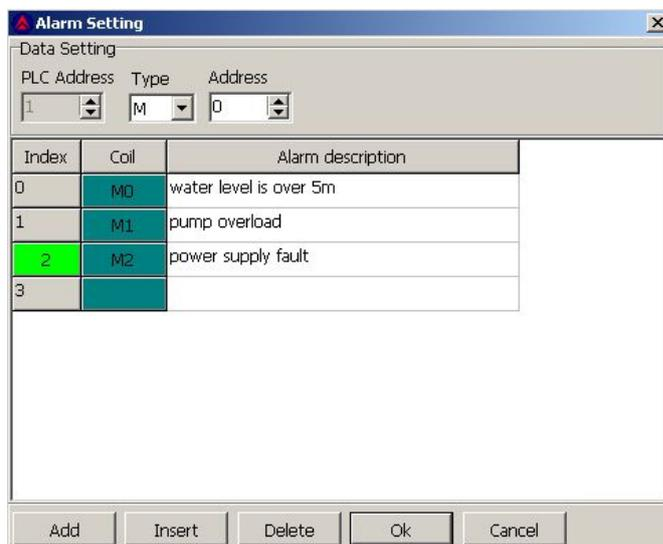

When SH-300 is working normally, if there is any failure alarm or M0 and M2 are ON, the flashing alarm screen will prompt automatically on SH-300 as in the following:

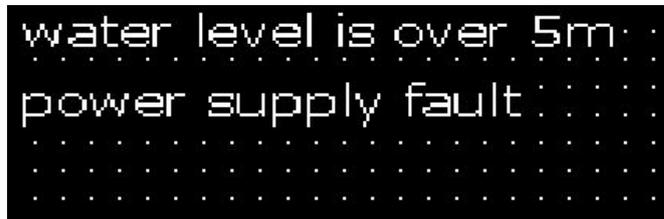

If the alarm failure is not corrected, the failure alarm information will flash and be displayed on SH-300. If the failure is corrected, the SH-300 will resume normal display. If the system is in examination and repair, user can check the failure alarm records via the “ALM” key on the panel. After the checking, press “ESC” key to return to the main interface.

## 2.6 User-defined SH300 system information

SH300 provides completely open system information menu structure, which provides user with completely self-defined menu. You can use any language system to edit your information menu and at the same time the coordinate position of the menu can be relatively changed according to your demand.

After standard installation of SH300 software, the default information menu will be loaded automatically when downloading data. The menu option lies in the submenu “**Immanent resource**” of the menu “**Tool**”.



Click “**Immanent resource**”, then the following diagram will be shown:

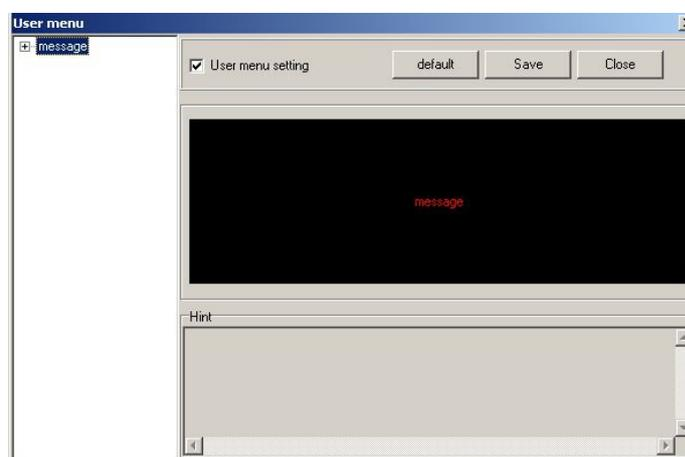

Click “default” and then click “message” on the left column. The seven information submenu “No response”, “Password menu”, “Input Password”, “Login OK”, “Password error”, “Logout OK”, “No alarm information” will be displayed as in the following diagram:

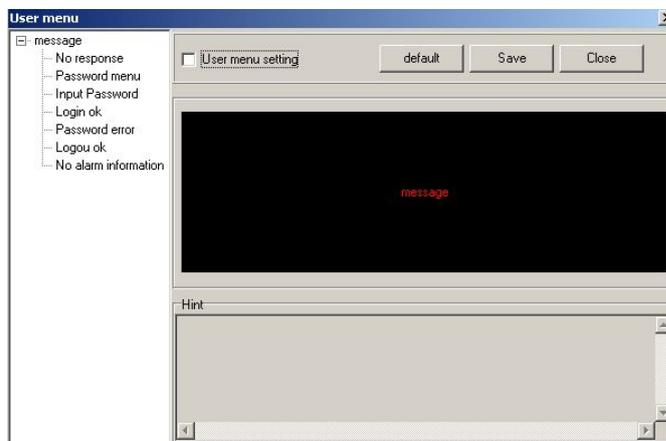

Click the “no response” submenu, the communication interface information between SH-300 and PLC will be displayed as in the following diagram:



If the text and the position of the information in the screen need to be changed, cross “user menu setting” check box and click “No response...”, the following prompting frame will be displayed as the following:

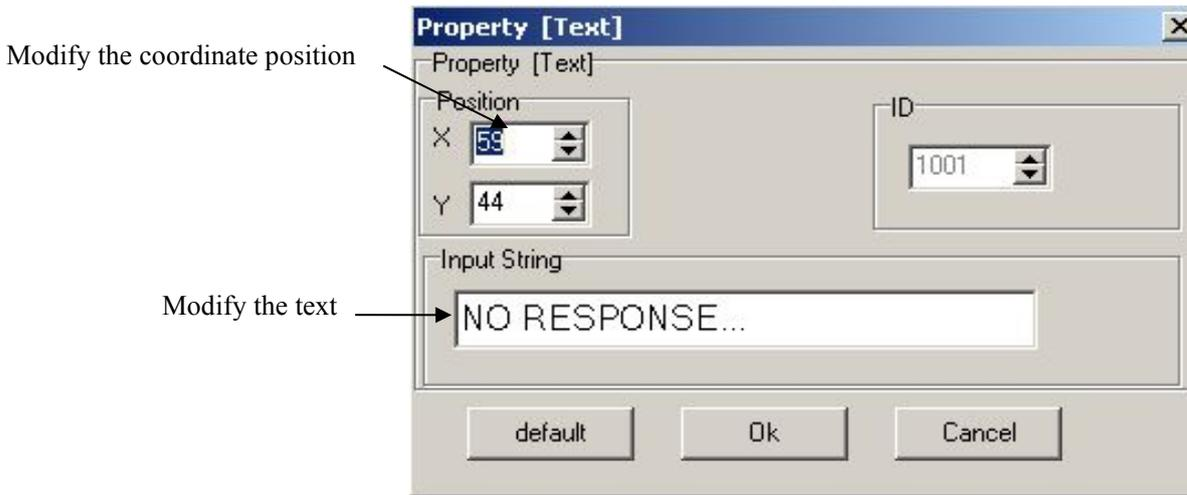

In this property frame, user can modify the X and Y coordinate position of the menu information (at the top left corner, it is the original coordinate position (0, 0) of X and Y) and the contents of the text information of the text frame (supporting multi language system). If “Default” is selected, which means the default interface will be displayed when communication. The displayed text is “no response...” and the coordinate position is X0 and Y0 as in the following diagram when SH-300 is communicating with PLC.



**Example:** Modify the default text from “no response” into “transmit data” and preserve the coordinate position. Click “OK” button to confirm. After the modification, when SH-300 is communicating with PLC, the following diagram will be displayed.



Click the “password menu” submenu, the password set interface will be displayed as in the following diagram. The password is the same one as set under the submenu “SH-300 Config” of the menu “Screen”.



The password set interface includes “LOGIN”, “LOGOUT”, “ESC EXIT” (default information). If the text of the information in the screen need to be changed and the position need not to be changed, cross “**user menu setting**” check box and double click the text needed to be changed, the following prompting frame will be displayed as the following:

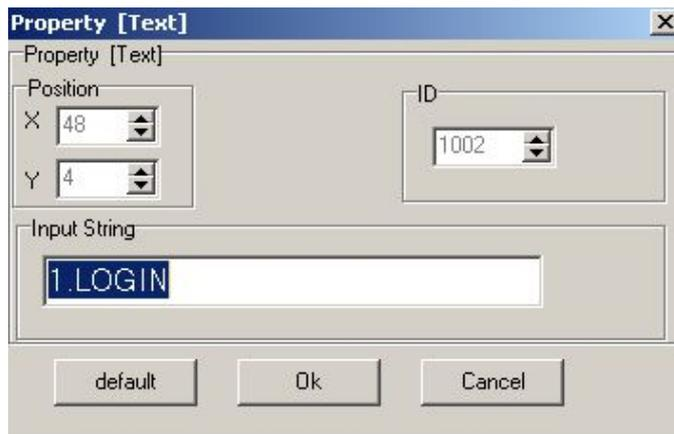

In the above property frame, the text information contents can be modified in the text frame (supporting multi language system). If “Default” is selected, the default password interface will be displayed. The displayed text is “LOGIN”, “LOGOUT”, “EXIT”. In the password set situation, press “Enter” key, the following diagram will be displayed:





**Example:** Substitute the text “ENTER” for “LOGIN”, “QUIT” for “LOGOUT” and “RETURN” for “EXIT”. Click “OK”, the following diagram will be displayed.



Click the “**Input password**” submenu, then the password input interface will be displayed as in the following diagram.

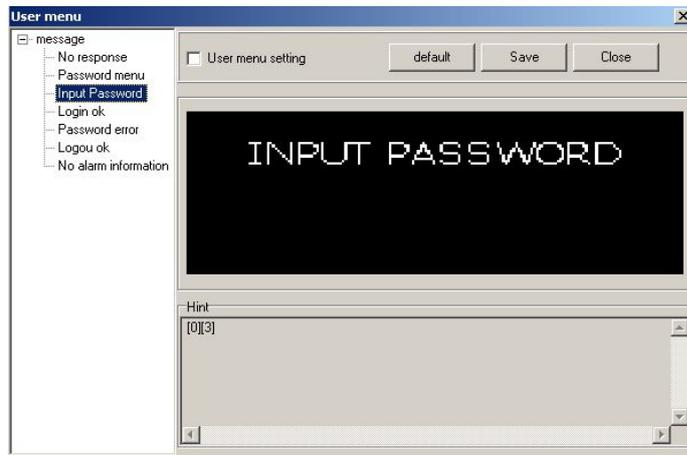

If the text and the position of the information in the screen need to be changed, cross “**user menu setting**” check box and double click “Input Password”, the following prompting frame will be displayed as the following:

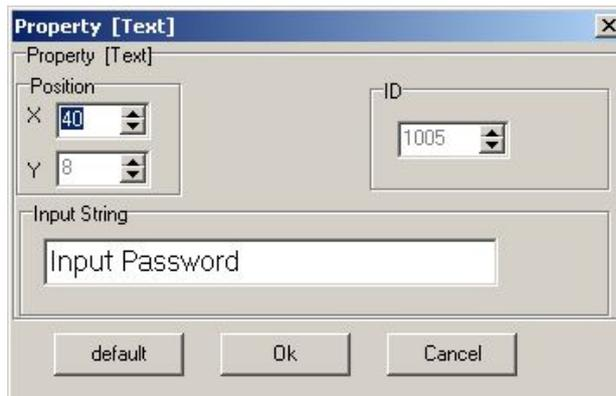

In this property frame, user can modify the X coordinate position of the menu information and the Y coordinate position is fixed (at the top left corner, it is the original coordinate position (0, 0) of X and Y) and the contents of the text information of the text frame (supporting multi language system). If “Default” is selected, which means the default interface will be displayed when communication. The displayed text is “Input password” and the coordinate position is X40 and Y8. And the position of the password input is also fixed as in the following diagram:



**Example:** substitute the text “password” for “Input password”, modify the position X to 0 and the position Y is fixed. Click “OK”, the following diagram will be displayed:



Click the “Login OK” submenu, then the password being successfully input interface will be displayed as in the following diagram:



In this interface, there are two lines of texts “Login Success”, “Press any key” (default information).

If the text and the position of the information in the screen need to be changed, cross “**user menu setting**” check box and double click the modifying text (take “Login Success” for example) the following prompting frame will be displayed as the following:

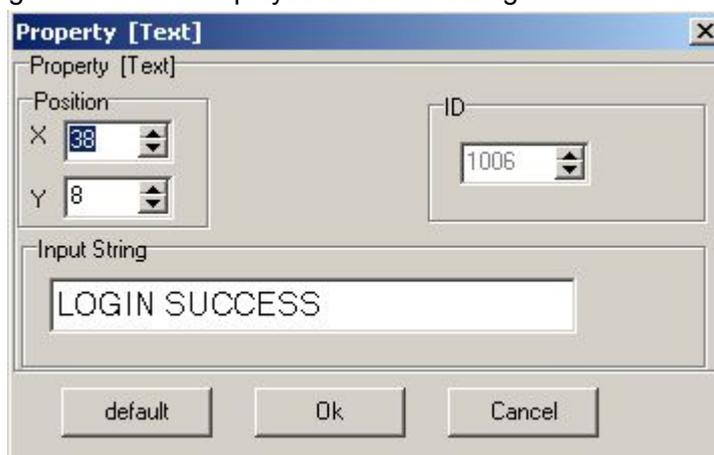

In this property frame, user can modify the X and Y coordinate position of the menu information (at the top left corner, it is the original coordinate position (0, 0) of X and Y) and the contents of the text information of the text frame (supporting multi language system). If "Default" is selected, which means the default interface will be displayed when communication. The displayed text is "Login Success" and the coordinate position is X38 and Y8 as in the following diagram:

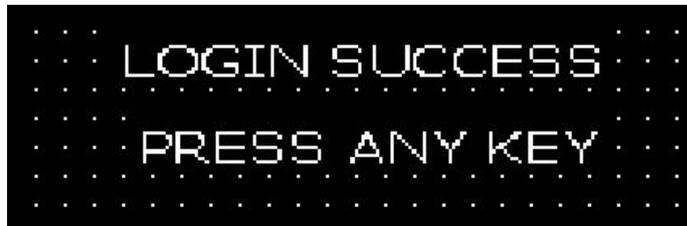

**Example:** Substitute the text "CORRECT PASSWORD" for "LOGIN SUCCESS" and "CONTINUE" for "PRESS ANY KEY". Then click "OK". The following diagram will be displayed:

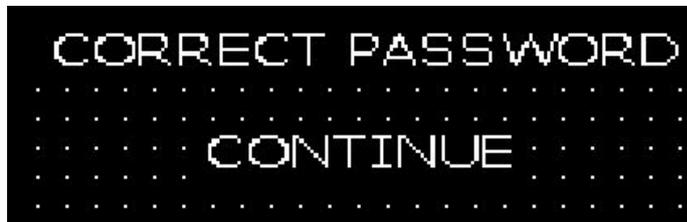

Click the "Password error" submenu, the password being error prompting interface will be displayed as in the following diagram:

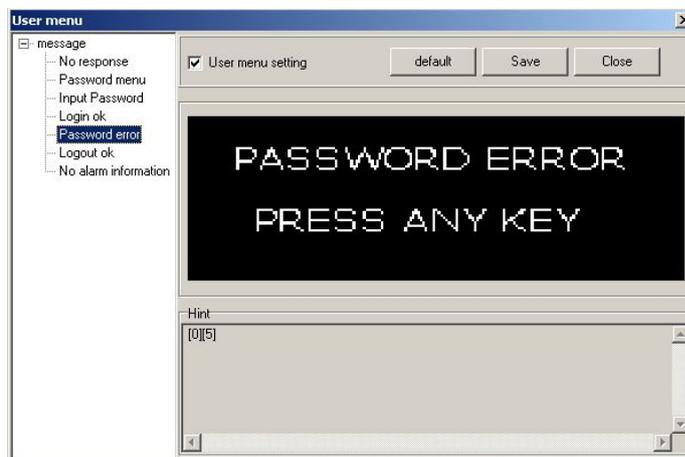

In this interface, there are two lines of texts "Password Error", "Press any key" (default information).

If the text and the position of the information in the screen need to be changed, cross "user menu setting" check box and double click the modifying text (take "PASSWORD ERROR" for example), the following prompting frame will be displayed as the following:

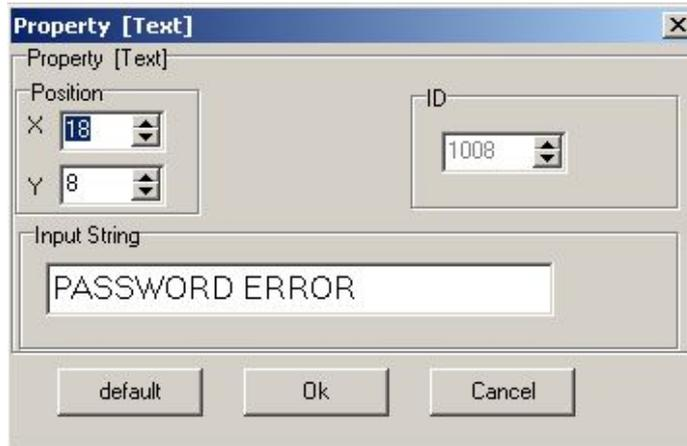

In this property frame, user can modify the X and Y coordinate position of the menu information (at the top left corner, it is the original coordinate position (0, 0) of X and Y) and the contents of the text information of the text frame (supporting multi language system). If “Default” is selected, which means the default interface will be displayed when communication. The displayed texts are “PASSWORD ERROR” and “PRESS ANY KEY” as in the following diagram:

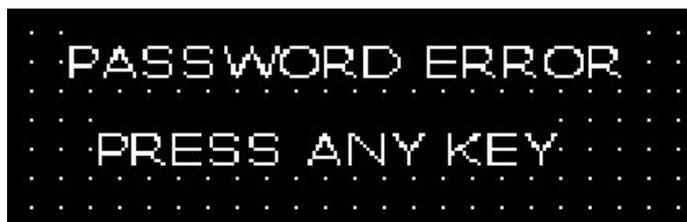

**Example:** Substitute the text “PASSWORD ERROR” for “IT IS WRONG” and “CONTINUE” for “PRESS ANY KEY”. Then click “OK”. The following diagram will be displayed:

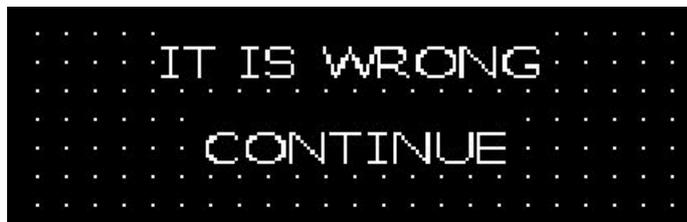

Click the “Logout OK” submenu, the password being closed interface will be displayed as in the following diagram:

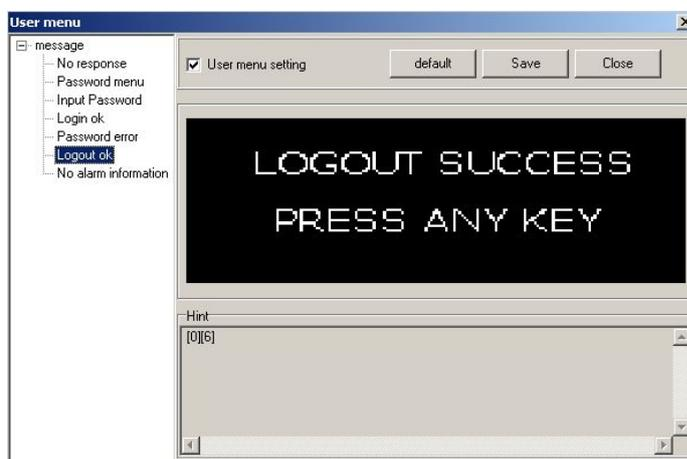

In this interface, there are two lines of texts “LOGOUT SUCCESS”, “PRESS ANY KEY” (default information).

If the text and the position of the information in the screen need to be changed, cross “**user menu setting**” check box and double click the modifying text (take “LOGOUT SUCCESS” for example), the following prompting frame will be displayed as the following:

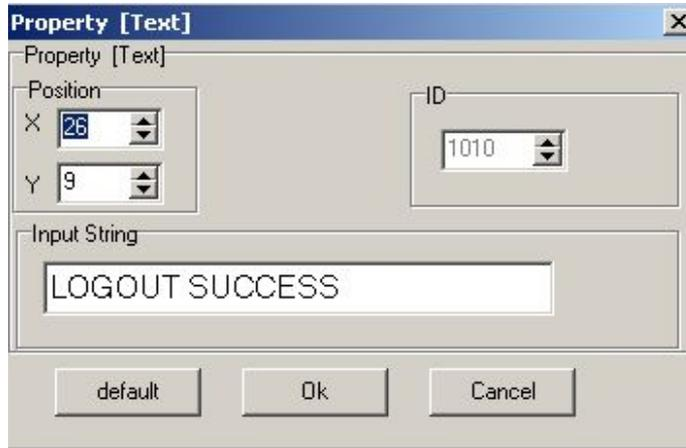

In this property frame, user can modify the X and Y coordinate position of the menu information (at the top left corner, it is the original coordinate position (0, 0) of X and Y) and the contents of the text information of the text frame (supporting multi language system). If “Default” is selected, which means the default interface will be displayed when communication. The displayed texts are “LOGOUT SUCCESS” and “PRESS ANY KEY” as in the following diagram:

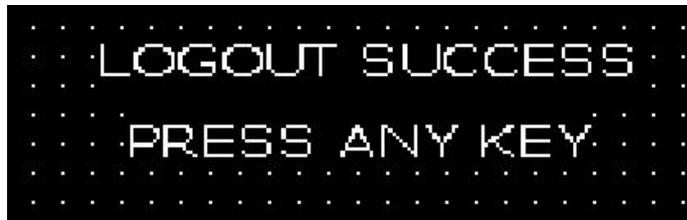

**Example:** Substitute the text “REWRITE PASSWORD” for “LOGOUT SUCCESS” and “CONTINUE” for “PRESS ANY KEY”. Then click “OK”. The following diagram will be displayed:



Click the “**No alarm information**” submenu, there being no alarm in the program prompting interface will be displayed as in the following diagram:

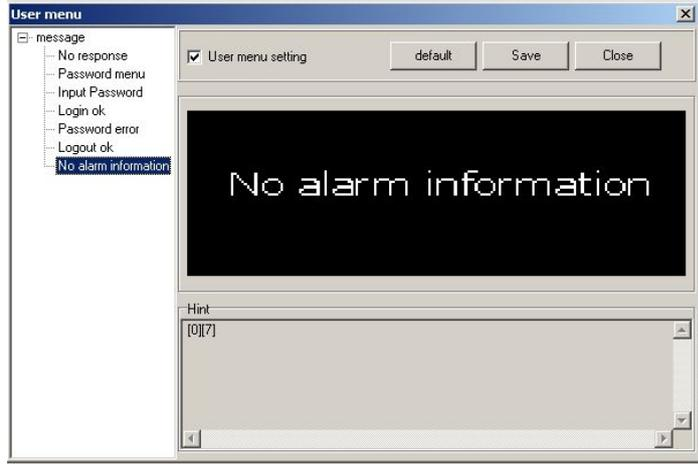

If the text and the position of the information in the screen need to be changed, cross “**user menu setting**” check box and double click the text frame “NO ALARM INFORMATION”, the following prompting frame will be displayed as the following:

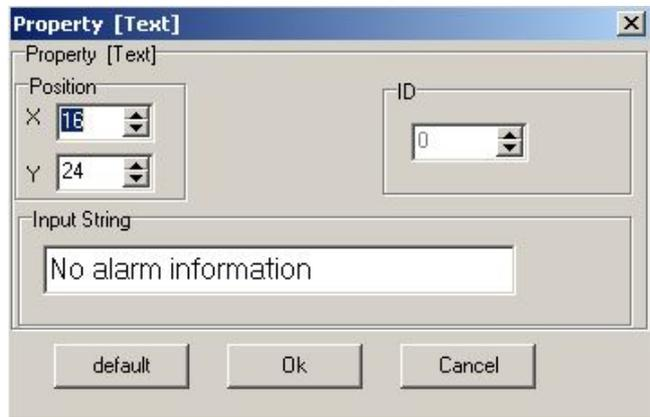

In this property frame, user can modify the X and Y coordinate position of the menu information (at the top left corner, it is the original coordinate position (0, 0) of X and Y) and the contents of the text information of the text frame (supporting multi language system). If “Default” is selected, which means the default interface will be displayed when communication. The displayed text is “NO ALARM INFORMATION” and the coordinate position is X16 and Y24 as in the following diagram:



**Example:** Substitute the text “alarm didn’t happen ” for “NO ALARM INFORMATION”. Then click “**OK**”. The following diagram will be displayed:

Under actual operation, if there is no alarm happens, press “**ALM**” key, the following diagram will also be displayed:



**Note:** After the modification of the self-defined information menu, click “Save” button and close the information frame, and write the edited program into SH-300, then the modified self-defined information will be written into SH-300.

## 2.7 Multi Language Editor

SH300 provides completely open multi language menu structure, which provides user with completely self-defined menu. You can use Chinese, English, French, German Czech and any other language to edit your message menu.

LangEditor is a characteristic language editor, which makes it reality that the menu supported SH300 software will be displayed in multi language.

After installation, the default English system menu will be loaded automatically in SH300 software. Open the LangEditor.exe file in SH300 software installation folder, the following interface will be displayed.

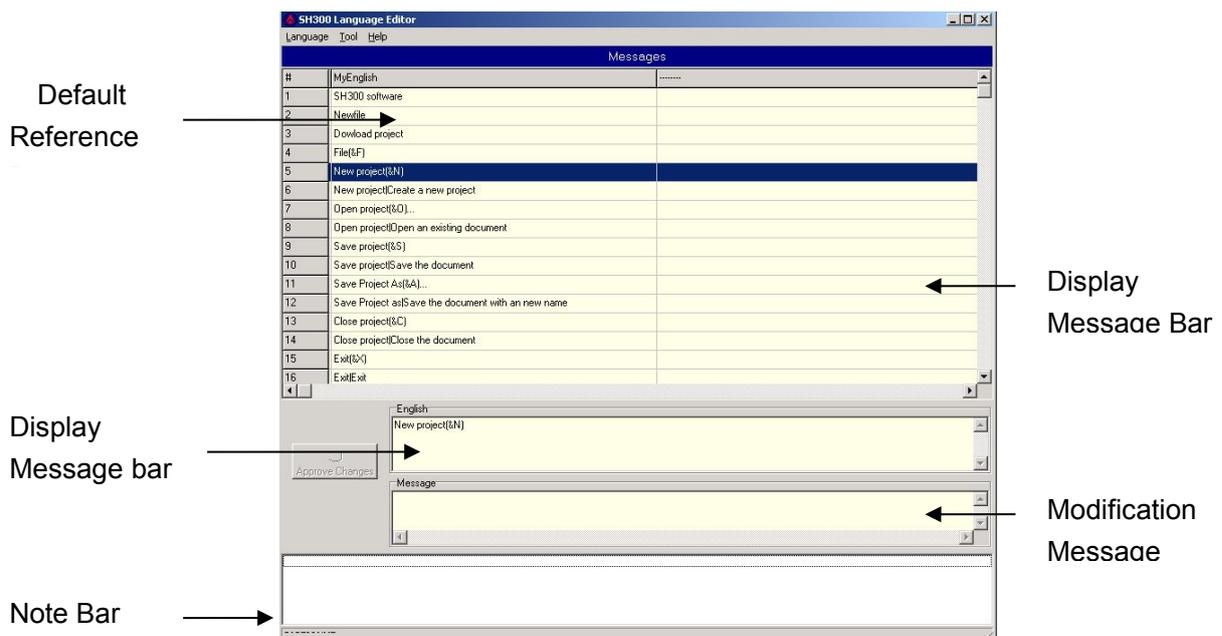

- ※Default reference bar: to display the default English menu bar;
- ※Display Message Bar: to display the modifying message bar;

- ※Display Message: to display the message menu;
- ※Modification Message: to modify the message menu;
- ※Note Bar: in find function, the relative message after finding will be displayed in the bar.

Click “**language**” menu, the pulldown menu is shown as the following, including “Open Language File”, “Save language File”, “Close Language File” and “Exit”.

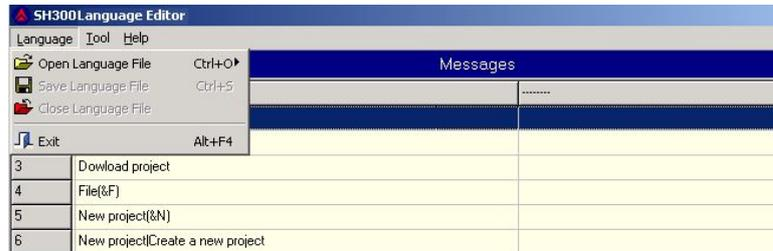

Take a text as an example to introduce the operation of the SH300 Langeditor.

**Example:** substitute the text “user-defined system information” for “Immanent resource”.  
First, run the “**Langeditor.exe**” file .

Second, click **Language**→**Open Language File**→**English** in the **Language** Menu.

Then click “**Search**” under “**Tool**” menu.

The following diagram will be displayed.



Input the text “Immanent resource” in the **Search Message** text frame. Choose “Original” as **Message type**. Then click “**Search**”. The information you want to change will be displayed in the **Remark Bar** as in the following diagram:

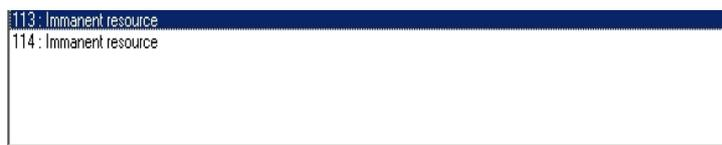

From the search result, the searched “Immanent resource” lies in Line 113 and Line 114. Browse Line 113 and Line 114. Double click Line 113, and the “Immanent resource” will be changed into “User-defined system information” in the Modification Message bar. By the same method, do the modification in Line 114.

Then, click “Approve Change” to confirm the modification.

Finally, select Language → Save Language File or press Ctrl+S to save the file and then exit the language editor.

Reopen the SH300.exe file and the relative modified menu will be found modified.



## 2.8 Operation Example

### Subject: The Drying Boxes Control System

#### Control requirements:

- (1) Via SH-300 to monitor the work status of three groups of heating units;
- (2) Via SH-300 to observe the actual temperature and change the preset temperature of the drying boxes;
- (3) Via SH-300 to observe the actual speed and change the preset speed of the motor;
- (4) Via SH-300 to set alarm information of abnormal work;

#### Operation Procedure:

1. Open SH300 software and click “New Project”, a prompting dialogue frame will be shown as follows:  
Select PLC type (take Mitsubishi (FX) for example), COM port and the other corresponding parameter and then click OK to confirm.

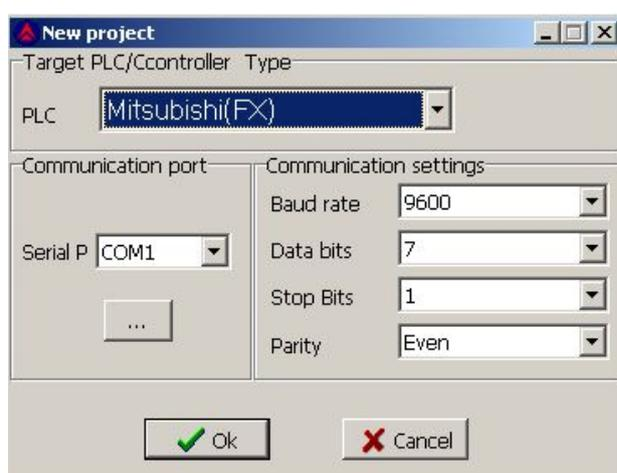

2. Make the main Screen 1 “Drying Box Control Menu” and input the text “Drying Box Control Menu” in the screen description bar.  
Set function key ①, set its property for jumping to Screen 2 and input the text “Temp” for temperature setting on its right;  
Set function key ②, set its property for jumping to Screen 3 and input the text “State” for state monitoring on its right;  
Set function key ③, set its property for jumping to Screen 4 and input the text “Motor” for motor setting on its right;  
Input the text “【ALM】Alarm list” which can prompt user to press ALM key to enter alarm list bar.



3. Make Screen 2 “Temperature Setting”

Click “New Screen” or  icon, the following dialogue frame will be displayed:

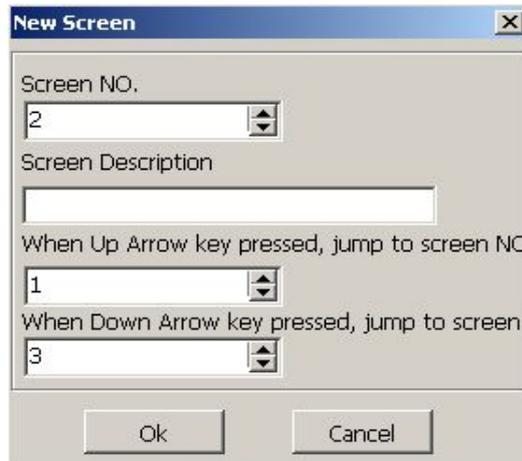

Correctly select “2” as the screen number, input the screen description “Temperature Setting”,select “1” as the up-jumping screen number and select “3” as the down-jumping screen number as in the following diagram:

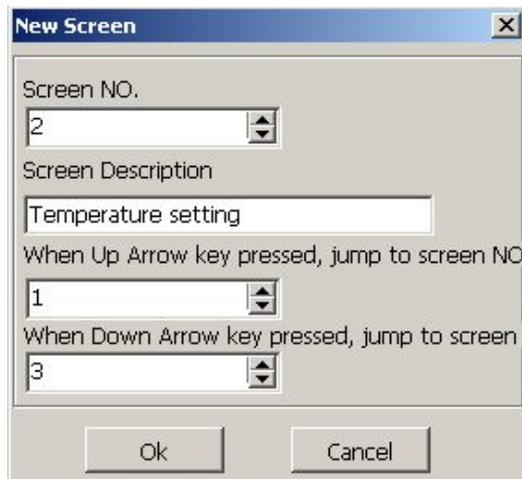

Press “OK” key to confirm and enter Screen 2. And place the text “Target”, “Current”, “Temp” in proper place as the following diagram:



Select “Register” under “Object” menu or click  in the tool bar. Move the mouse to proper place under “Target” and click the left key of the mouse to confirm. Then set the parameter of the register, Address=D0, Digits=4, Decimal=2, Mode=Dec. Select “Set” and “Limit” check box. Then place the text “°C” on its right as shown in the following diagram:

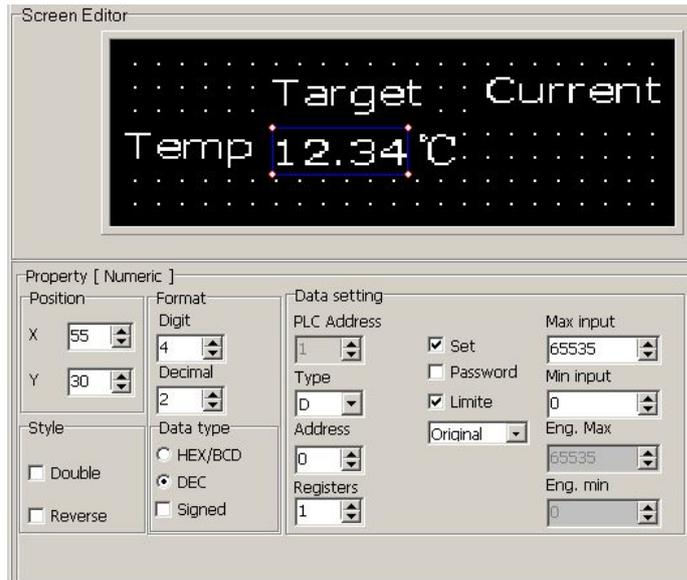

Select "Register" under "Object" menu or click  in the tool bar. Move the mouse to proper place under "Current" and click the left key of the mouse to confirm. Then set the parameter of the register, Address=D1, Digits=4, Decimal=2, Mode=Dec. Don't select the "Set" check box. Then place the text "°C" on its right as shown in the following diagram:

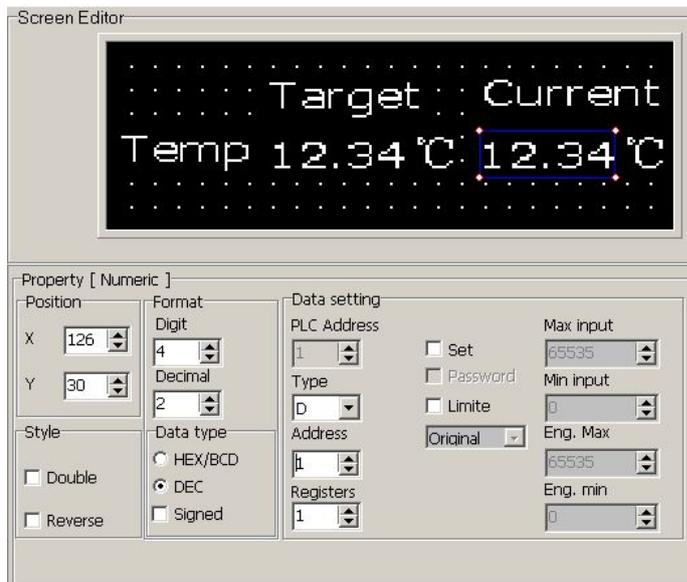

4. Make Screen 3 "State Monitoring"

As stated above, create the Screen 3. The input the text "Heating Unit 1", "Heating Unit 2", "Heating Unit 3" in proper place in the screen as in the following diagram:

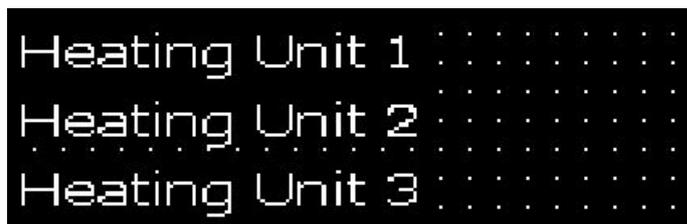

Select “Indicator” under “Object” menu or click  in the tool bar. Move the mouse to proper place behind “Heating Unit 1” and click the left key of the mouse to confirm as in the following diagram. And add two other indicators as the above.

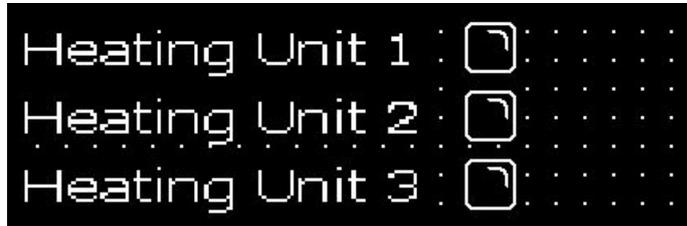

Set the “Indicator” one by one.

The setting of the indicator for the heating unit 1 is listed as below: Address=M30, Shape=Square, logic=positive;

The setting of the indicator for the heating unit 2 is listed as below: Address=M40, Shape=Square, logic=positive;

The setting of the indicator for the heating unit 3 is listed as below: Address=M50, Shape=Square, logic=positive.

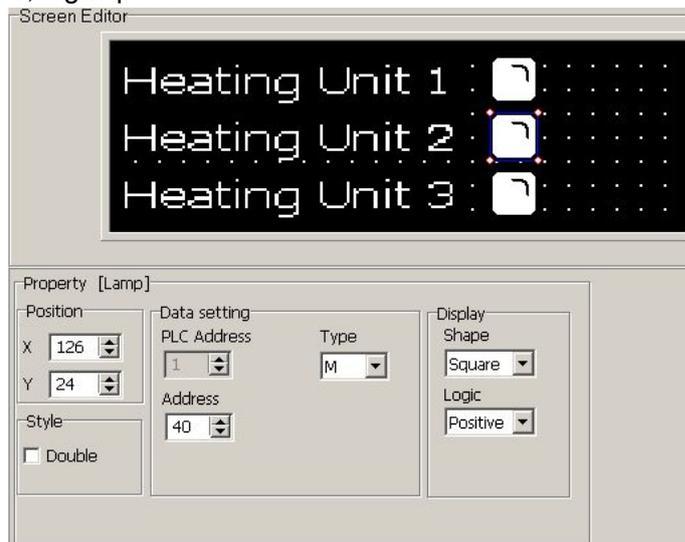

5. Make Screen 4 “Motor Setting”

As stated above, create the Screen 4. The input the text “Target”, “Current”, “Motor”, “Speed” in proper place in the screen as in the following diagram:



Select “Register” under “Object” menu or click  in the tool bar. Move the mouse to proper place under “Target” and click the left key of the mouse to confirm. Then set the parameter of the register, Address=D80, Digits=5, Decimal=1, Mode=Dec. Select the “Set” check box as shown in the following diagram:

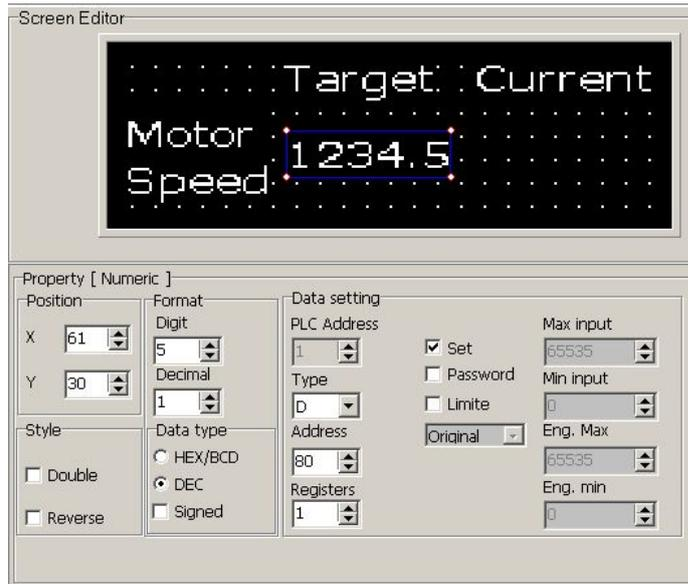

Select "Register" under "Object" menu or click  in the tool bar. Move the mouse to proper place under "Current" and click the left key of the mouse to confirm. Then set the parameter of the register, Address=D90, Digits=5, Decimal=1, Mode=Dec. Don't select the "Set" check box as shown in the following diagram:

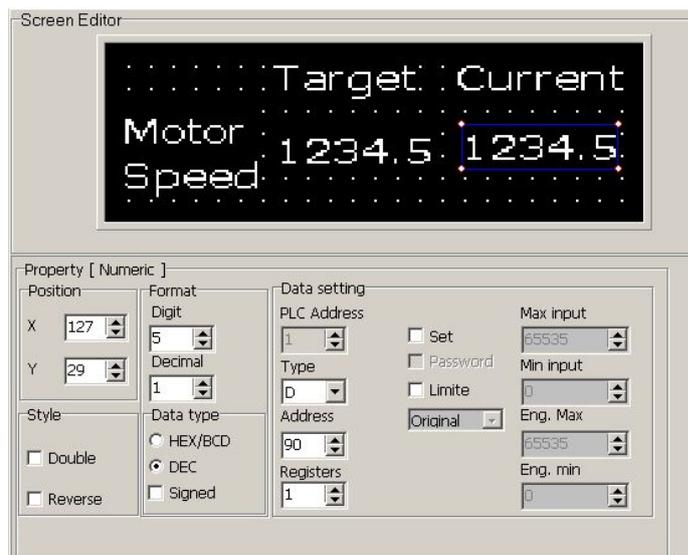

6. Make Screen 5 "Alarm List"

Click  in the tool bar. A prompting dialogue frame as the following will show. Set the initial coil type as M88 first. And the alarming information for M88 is "Be abnormal for unit1"; the alarming information for M89 is "Be abnormal for unit 2"; the alarming information for M90 is "Be abnormal for unit 3"; as shown in the following diagram:



序号	线圈	报警内容
0	M88	Be abnormal for unit 1
1	M89	Be abnormal for unit 2
2	M90	Be abnormal for unit 3
3		

Click "OK" to confirm. Thus the whole control file of the drying box system is finished. Then click "Save Project "

7. Download the drying box project data into SH-300.



## Manipulation

### 3.1 Download Window

1. Connect the operating unit interface to the configuration computer using a **SH-PC** cable.
2. Confirmed SH-300 has added on the DC24V power source.
3. Press  and start to download the data, the screen appears the downloading picture prompt frame.

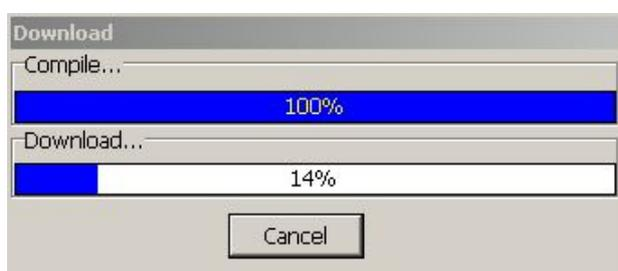

**Note :** Don't cut off the power supply when SH-300 is receiving data from the configuration computer.

### 3.2 Communication

When you finished the downloading of the project data file, cut off the power supply and remove the communication cable SH-PC. Connect SH-300 to PLC with a communication cable and check the setting of PLC communication parameters. Meanwhile add the DC24V power to PLC and SH-300. Then SH-300 will enter the normal operation condition.



**Note:** when SH-300 communicates with PLC, the initial window appears as shown above. Please press “^”key or “v”key the system will be normal. If the system isn't normal you should check the communication of SH-300 and PLC.



### 3.3 Shifting the windows

Take the project windows of the drying boxes as an example to introduce the manipulation of SH-300.

SH-300 displays window No.1 at first (the initial window is No.1).



Window No.1 is a main menu window. Pressing ① switch to the window of temperature setting(No.2) that is shown as follows:



### 3.4 System Password

After setting system password, you must input the password before you change the data. Then press "SET" key ,it will appear the picture as follows :



Select "1 ,LOGIN" "2.LOGOUT" or "EXIT" with Up, Down keys and then press "ENT"

Select "1 ,LOGIN" the window will display as follows:

(select 2 to logout, select 3 to exit the window.)



Input the password (0-999999), which is shown as“\*”. Press ENT. If password is correct, it will show the window as follows:

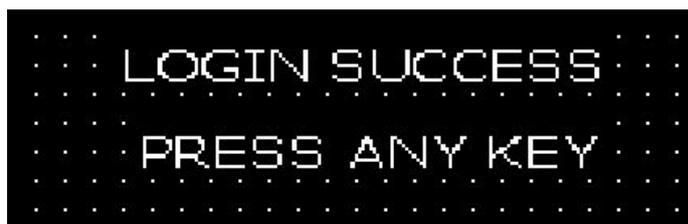

If password is incorrect, it will show the window as follows:

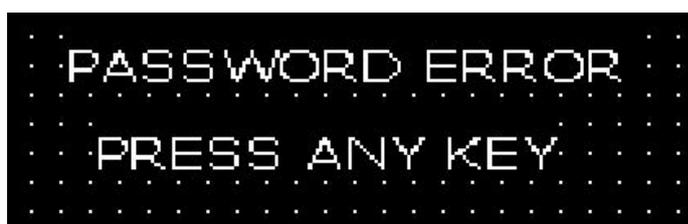

Then press ENT,return to the password window.

Select “2 ,LOGOUT” and Press ENT it will show the window as follows:

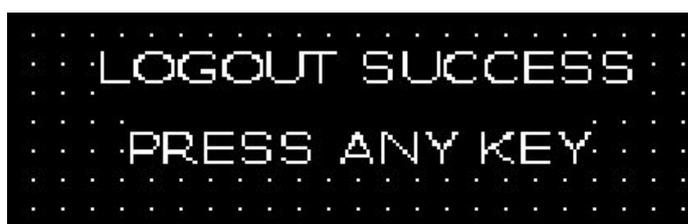

### 3.5 Data setting

When SH-300 display NO.2 picture press SET key and the setpoint of work temperature is flickering, you can change the cursor position by pressing “<” and “>”and change setpoint by pressing “^” and “v”.

Press ENT to confirm the input data, the data has been written into PLC register D100, and the data will be normally displayed and not flickering. Press ENT to enter the setting mode again

### 3.6 State Monitoring

After finished the setting of register, press “^” and return to the main menu ,SH-300 is shown as follows:



Press ② enter the window of state monitoring (No.3), which is shown as follows:

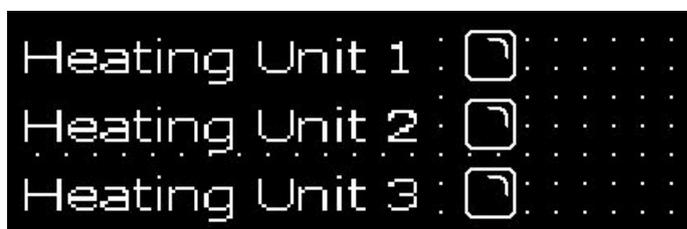

SH-300 will display the state monitoring window for three group heating units. When a heating unit is running the indicator will be show as full state and operator can monitor the running state of the heating units by the window.



# Connection with PLC

# 4

## 4.1 Mitsubishi FX Series

SH-300 can communicate with the programming port of all types of Mitsubishi FX series PLC or the FX2N-422BD module of the FX2N series.

### SH-300 software configuration:

Item	Content		
SH-300 COM port	9 pin COM port		
PLC COM port	Programming port/ FX2N-422BD		
Default parameter	9600bps、7bits、1stop、Even		
Station No.	1(1 is fixed and can't be changed)		
Distance (Max.)	70m		
Communication mode	RS422/ Programming port		
Cable type	Special cable/SC09		
PLC series	FX0S	FX0N	FX2N
Inner relay address	M000-M511	M000-M511	M0000-M3071
Register address	D00-D31	D000-D255	D0000-D7999

### Connection guidance of Special cable

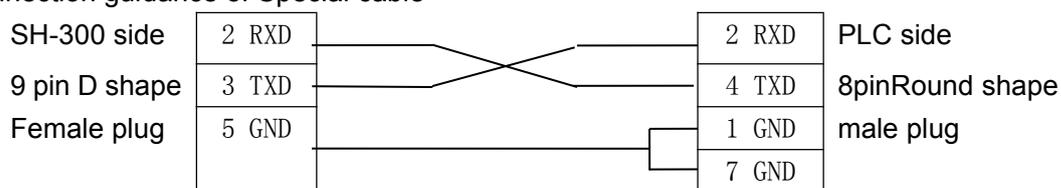

The picture for 8 pin Round shape Female plug

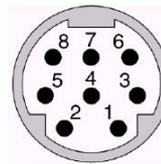

**Note:** In order to insure the normal communication you must use SC09 when you select the programming cable of the FX series

## 4.2 Siemens S7-200 Series

SH-300 can communicate with the programming port or external communication port of Siemens S7-200 series through PPI protocol.

### SH-300 software configuration:

Item	Content
SH-300 COM port	RS485 COM port
PLC COM port	Programming port/ external communication port
Default parameter	9600bps、8bits、1stop、Even
Station No.	2-126 ,2 is Windows default
Distance (Max.)	100m (twisted-pair)
Communication mode	RS485
Cable type	Special cable
Inner relay address	M0.0-M31.7
Register address	VW0000-VW5118

### Connection guidance of Special cable

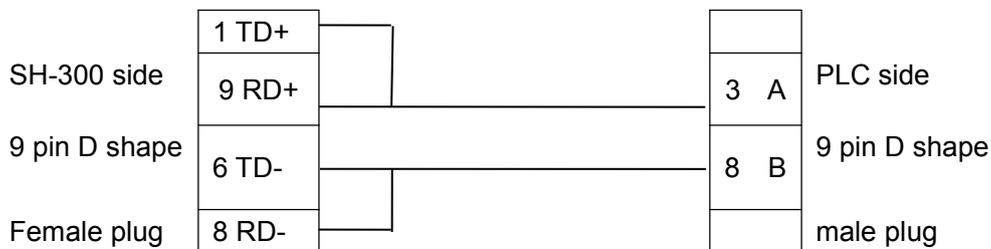

( when SH-300 communicates with S7-200 series PLC you are recommended to use the program the programming cable )

## 4.3 OMRON C Series

SH-300 can communicate with the programming port of CQM、CPM series PLC through HOST-Link protocol.

### SH-300 software configuration:

Item	Content
SH-300 COM port	9 pin COM port
PLC COM port	Programming port/ external communication port
Default parameter	9600bps、7bits、2stop、Even
Station No.	0-99 ,0 is Windows default
Distance (Max.)	15m
Communication mode	RS232
Cable type	Special cable
Inner relay address	IR200.0-IR231.F(IR2000.0-IR231.15)
Register address	DM000-DM1024

Note: Because CQM-CPU11 and CAPM1A have only one COM port. you must use the programming cable or the CIF01-CAB Communication module of the OMRON communicating with SH300

### Connection guidance of Special cable

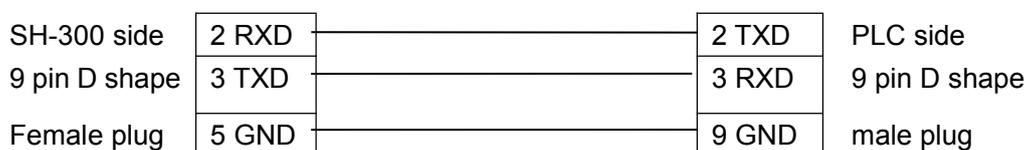

Note: the register won't be set unless the CPU must work in the monitor mode

## 4.4 Delta DVP Series

SH-300 can communicate with the delta DVP series PLC, the communication port is the programming port of PLC

### SH-300 software configuration:

Item	Content
SH-300 COM port	9 pin COM port
PLC COM port	Programming port
Default parameter	9600bps、 7bits、 1stop、 Even
Station No.	1-254 , 1 is Windows default
Distance (Max.)	15m
Communication mode	RS232
Cable type	Special cable
Inner relay address	M0-M1270
Register address	D0-D1066

Connection guidance of Special cable:

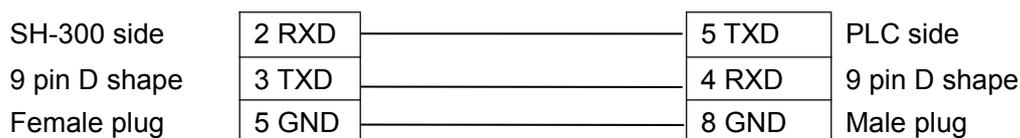

( when SH-300 communicates with Delta DVP series PLC you are recommended to use the the programming cable )



### 4.5 Panasonic FP Series

SH-300 can communicate with Panasonic FP series PLC, the communication port is the programming port of PLC or external communication port.

SH-300 software configuration:

Item	Content
SH-300 COM port	9 pin COM port
PLC COM port	Programming port
Default parameter	9600bps、8bits、1stop、Odd
Station No.	1-32 ,1 is Windows default
Distance (Max.)	15m
Communication mode	RS232
Cable type	Special cable
Inner relay address	R0000-R875F
Register address	DT0000-DT6134

Connection guidance of SH-CAB-FP0 :

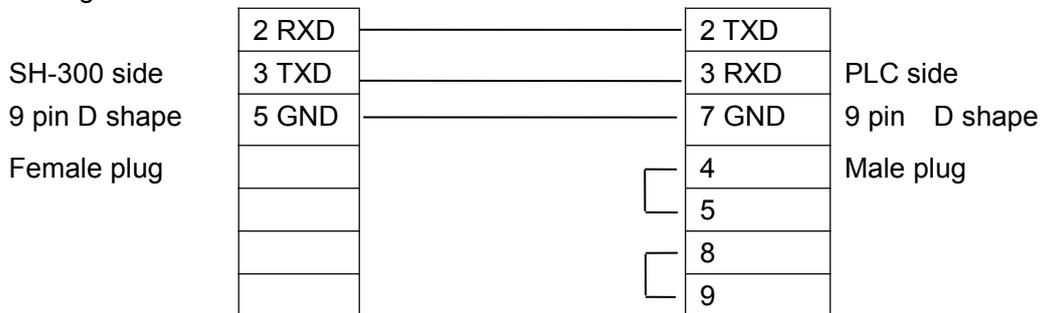

Connection guidance of SH-CAB-FP1 :

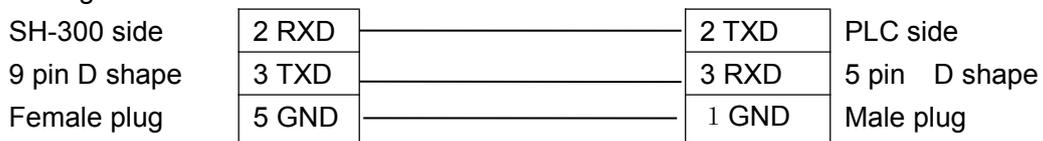

The picture for 5 pin Round shape Female plug

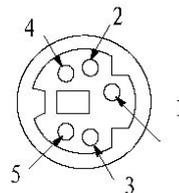

( when SH-300 communicates with Panasonic FP series PLC you are recommended to use the the programming cable )

### 4.6 Vigor VH Series

SH-300 can communicate with Vigor VH series PLC, the communication port is the Programme device assistant port of PLC

SH-300 software configuration:

Item	Content
SH-300 COM port	9 pin COM port
PLC COM port	Programming port
Default parameter	19200bps、7bits、1stop、Even
Station No.	0-255 ,0 is Windows default
Distance (Max.)	15m
Communication mode	RS232
Cable type	special cable
Inner relay address	M0-M5119
Register address	D0-D8191

Connection guidance of special cable

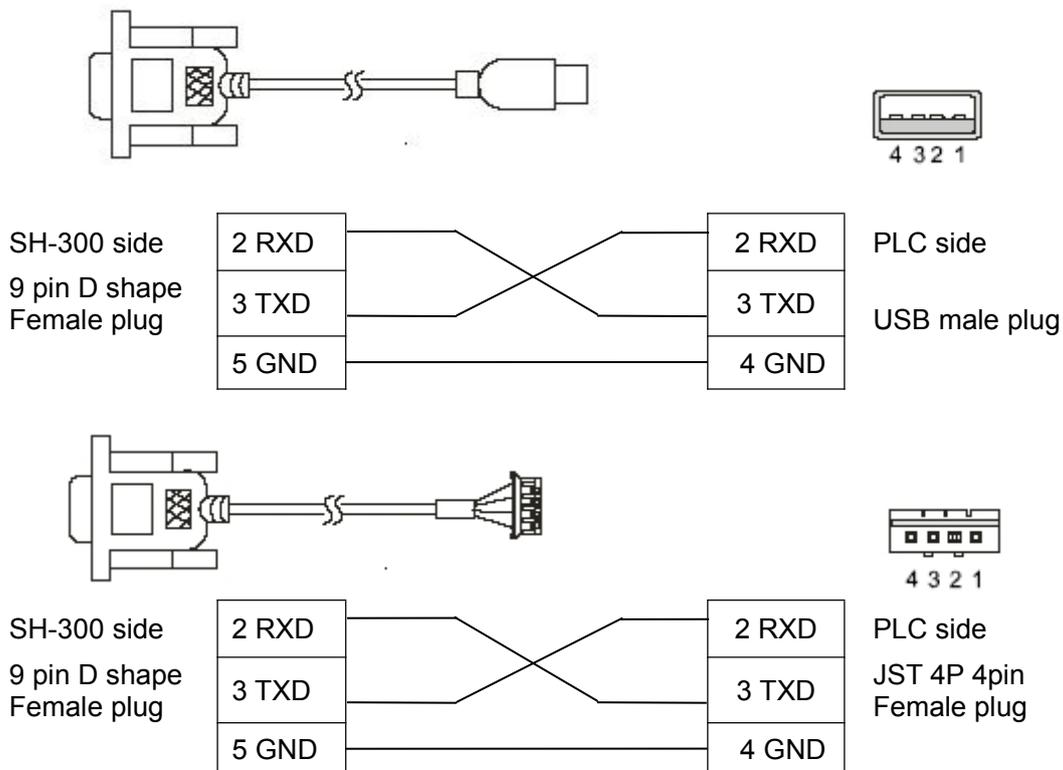

( when SH-300 communicates with Vigor VH series PLC you are recommended to use the programming cable )

### 4.7 Koyo S Series

SH-300 can communicate with Koyo S series PLC, the communication port is the programming port of PLC

SH-300 software configuration:

Item	Content
SH-300 COM port	9 pin COM port
PLC COM port	Programming port
Default parameter	9600bps、8bits、1stop、Odd
Station No.	1-99 ,1 is Windows default
Distance (Max.)	15m
Communication mode	RS232
Cable type	MD2-SZ applies to SZ、SH、SH series MD2-SG applies to SU、SG series
Inner relay address	M000-M377
Register address	R2000-R7777

Connection guidance of MD2-SZ:

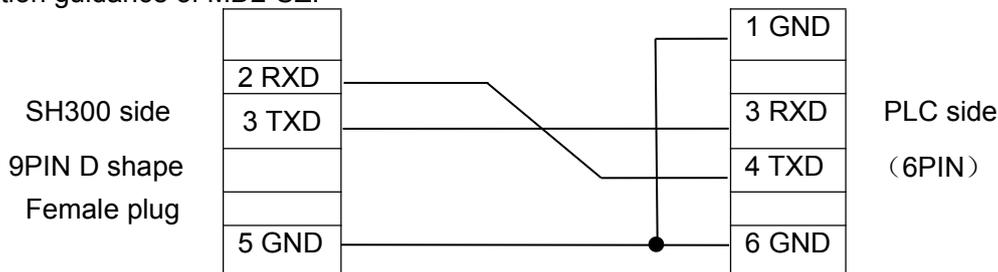

The picture for 6 pin RJ126 Female plug

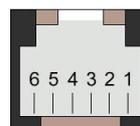

Connection guidance of MD2-SG:

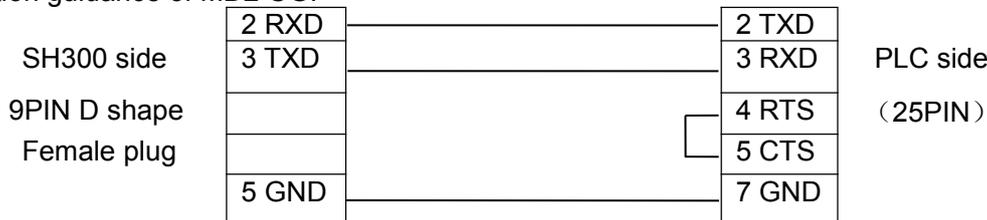

( when SH-300 communicates with Koyo S series PLC you are recommended to use the programming cable )

## 4.8 ADC DL05 Series

SH-300 can communicate with ADC DL05 series PLC, the communication port is the programming port of PLC., In order that the SH300 can communicate with ADC DL 05 series communication Port2 normally, ADC PLC must be correspondingly configured. To do this, the ADC Communication Protocol must be defined with the DirectSoft software, Select the “SETUP” submenu under “PLC” option in the DirectSoft ,Set up Communication Ports according to the picture indicated below.

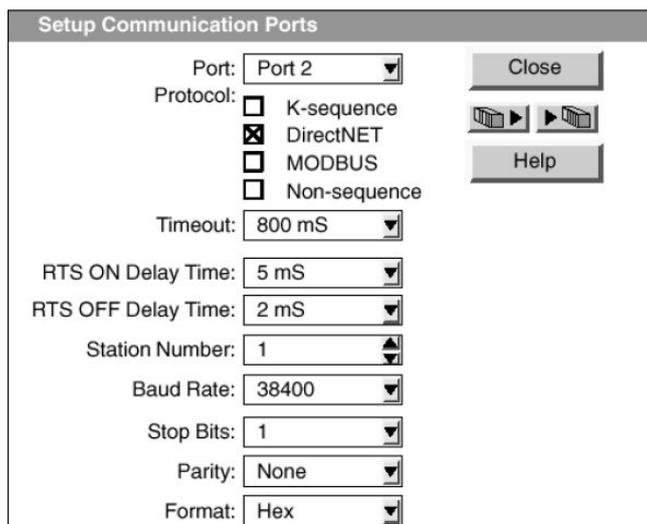

SH-300 software configuration:

Item	Content
SH-300 COM port	9 pin COM port
PLC COM port	Programming port
Default parameter(port1)	9600bps(fixed)、8bits、1stop、Odd(fixed)
Default parameter(port2)	300-38400bps, 8bits、1stop、Odd(default)
Station No.(port1)	1 (1 is fixed and can't be changed)
Station No.(port2)	1-99 ,1 is Windows default
Distance (Max.)	15m
Communication mode	RS232
Cable type	Special cable
Inner relay address	M0-M777
Register address	R0-R7777

Connection guidance of port 1 special cable:

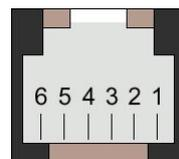
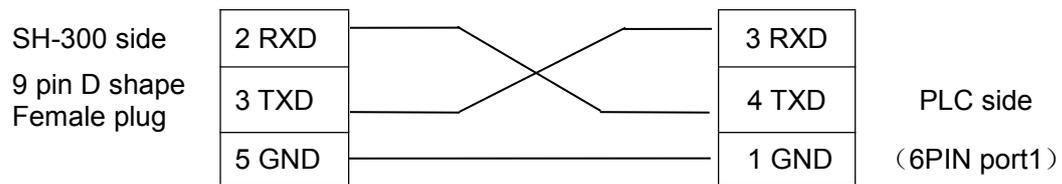

( when SH-300 communicates with ADC DL05 series PLC you are recommended to use the the programming cable )

## 4.9 FATEK FBs Series

SH-300 can communicate with FATEK FBs series PLC the communication port is the port 0 of PLC

SH-300 software configuration:

Item	Content
SH-300 COM port	9 pin COM port
PLC COM port	Programming port
Default parameter	9600bps、7bits、1stop、Even
Station No.	1-254 ,1 is Windows default
Distance (Max.)	15m
Communication mode	RS232
Cable type	Special cable
Inner relay address	M0000-M2001
Register address	R0000- R3839.R5000-R8071

Connection guidance of Special cable

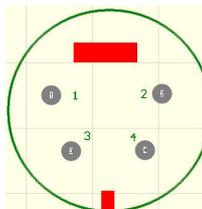
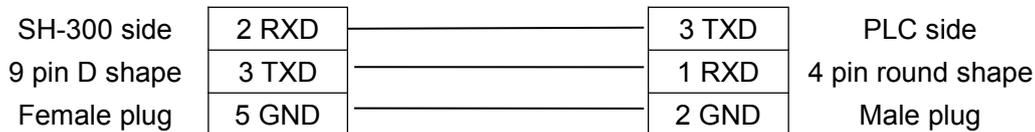

(when SH-300 communicates with FATEK series PLC you are recommended to use the programming cable )

### 4.10 Schneider NEZA/TWIDO Series

SH-300 can communicate with Schneider NEZA/TWIDO Series PLC through Modbus RTU protocol, the communication port is the programming port of PLC

SH-300 software configuration:

Item	Content
SH-300 COM port	RS485 COM port
PLC COM port	Programming port
Default parameter	19200bps、8bit、1stop、Even
Station No.	1—247, 1 is Windows default
Distance (Max.)	100m (twisted-pair)
Communication mode	RS485
Cable type	Special cable
Inner relay address	%M000-%M256
Register address	%MW0-%MW2999

Connection guidance of Special cable

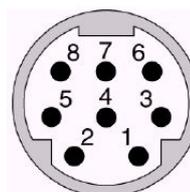
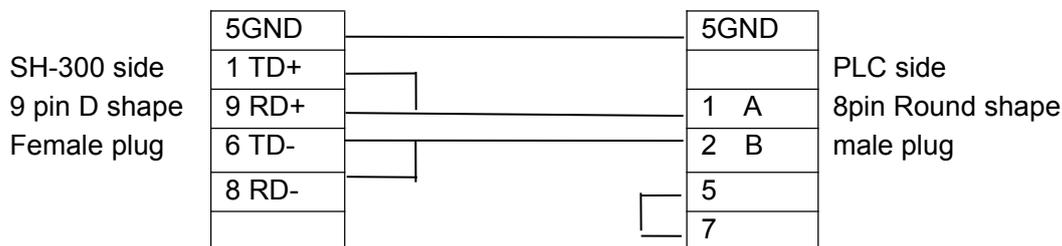

The picture for 8 pin Round shape Female plug

(when SH-300 communicates with Schneider NEZA/TWIDO Series PLC you are recommended to use the programming cable the switch on which is placed “3” position)

## 4.11 AB (AB-DF1 protocol) Series

SH-300 can communicate with the Allen-Bradley series PLC via AB-DF1 Protocol, the communication port is the programming port of PLC

SH-300 software configuration:

Item	Content
SH-300 COM port	9 pin COM port
PLC COM port	Programming port
Default parameter	9600bps、 8bits、 1stop、 None
Station No.	1 (1 is fixed and can't be changed)
Distance (Max.)	15m
Communication mode	RS232
Cable type	Special cable
Inner relay address	B3/9/10/11/12/13: 0-254
Register address	N7/9/10/11/12/13/14/15: 0-254

Connection guidance of Special cable

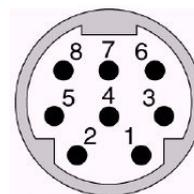
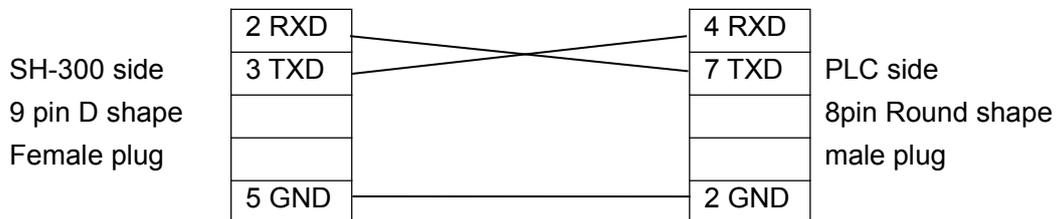

The picture for 8 pin Round shape Female plug

(when SH-300 communicates with Allen-Bradley (AB-DF1 Protocol) series PLC you are recommended to use the programming cable )



### 4.12 THINGET XC Series

SH-300 can communicate with THINGET XC series PLC, the communication port is the programming port of PLC

SH-300 software configuration:

Item	Content
SH-300 COM port	9 pin COM port
PLC COM port	Programming port
Default parameter	19200bps、8bits、1stop、Even
Station No.	0—255, 1 is Windows default
Distance (Max.)	15m
Communication mode	RS232
Cable type	Special cable
Inner relay address	M0-M7999
Register address	R0-R7999

Connection guidance of Special cable

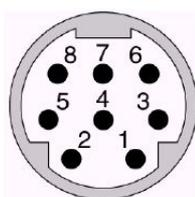
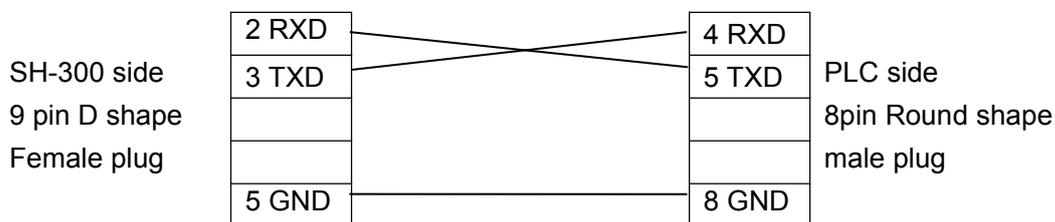

The picture for 8 pin Round shape Female plug

(when SH-300 communicates with THINGET series PLC you are recommended to use the programming cable )

### 4.13 Emerson EC20 Series

SH-300 can communicate with Emerson EC20 series PLC, before communication with SH-300 PLC need to be configured .setup port0 of PLC as Modbus communication protocol.

SH-300 software configuration:

Item	Content
SH-300 COM port	9 pin COM port
PLC COM port	Programming port
Default parameter	19200bps、8bits、1stop、Even
Station No.	0—255, 1 is Windows default
Distance (Max.)	15m
Communication mode	RS232
Cable type	Special cable
Inner relay address	M0-M1999 Y0-Y377(O)
Register address	D0-D7999 T0-T255

Please consult Emerson PLC user manual for particular address

Connection guidance of Special cable

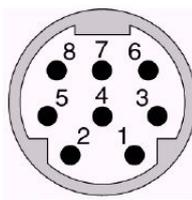
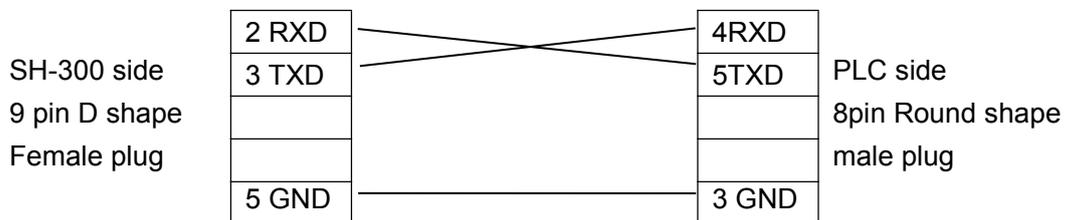

The picture for 8 pin Round shape Female plug

(when SH-300 communicates with Emerson EC20 series PLC you are recommended to use the programming cable )

### 4.14 HITACHI MICRO-EH Series

SH-300 can communicate with HITACHI MICRO-EH series PLC, the communication port is the programming port of PLC

SH-300 software configuration:

Item	Content
SH-300 COM port	9 pin COM port
PLC COM port	Programming port
Default parameter	19200bps、7bits、1stop、Even
Station No.	0 (0 is fixed and can't be changed)
Distance (Max.)	15m
Communication mode	RS232
Cable type	Special cable
Inner relay address	R0-R7BF M0-M3FFF
Register address	WR0-WRFFF WM0-WM3FFF

Connection guidance of Special cable:

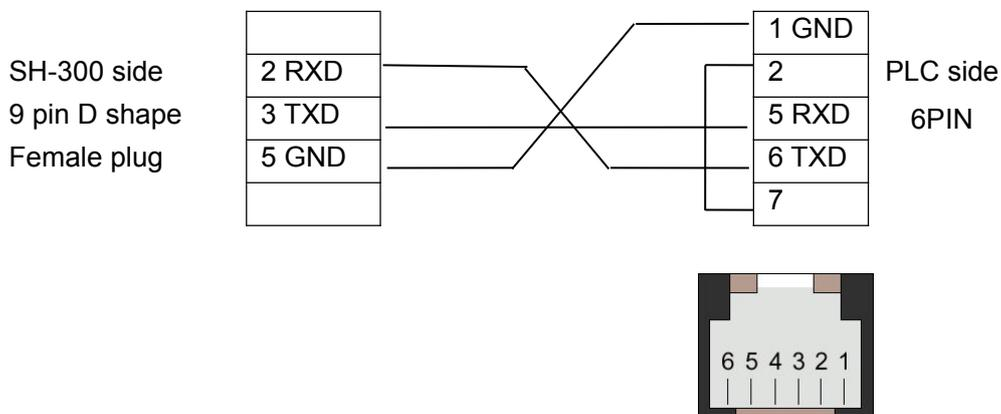

The picture for 6 pin Female plug

(when SH-300 communicates with HITACHI MICRO-EH series PLC you are recommended to use the programming cable )

## 4.15 KDN-K3 Series

SH-300 can communicate with KDN-K3 series PLC, the communication port is the programming port of PLC

SH-300 software configuration:

Item	Content
SH-300 COM port	9 pin COM port
PLC COM port	Programming port
Default parameter	9600bps、8bits、1stop、None
Station No.	1—31, 1 is Windows default
Distance (Max.)	15m
Communication mode	RS232
Cable type	Special cable
Inner relay address	I0.0-I7.7/ Q0.0-Q7.7/ M0.0-M31.7
Register address	AIW0-62/AQW0-62/AQW0-4094

Connection guidance of Special cable:

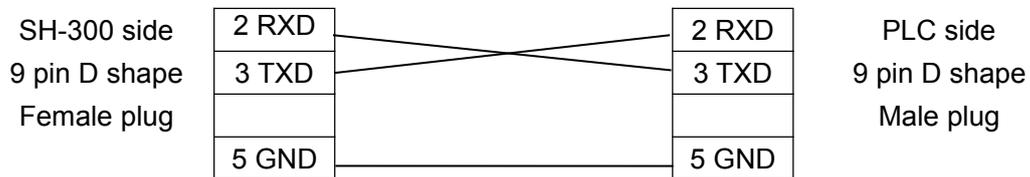

( when SH-300 communicates with KDN-K3 series PLC you are recommended to use the programming cable )

## 4.16 MODBUS RTU/ASCII and RTU/ASCII EXTEND protocol

### 1. Introducing Modbus Protocol

SH-300 communicates by using a master–slave technique, in which one SH-300(the master) can send query message. one programmable controller(the slave) responds according to the requested data supplied by SH-300. The Modbus protocol establishes the format for the master's query by placing into it the device address, a function code, any data to be sent, and error–checking field. The slave's response message is also constructed by using Modbus protocol. It contains fields confirming the action taken, any data to be returned, and an error–checking field. The returned data bytes contain the data collected by the slave, such as register values or coil status. If error occurred in receipt of the message, or if the slave is unable to perform the requested action, the slave will construct an error message and send it as its response.

### 2. MODBUS RTU/ASCII and RTU/ASCII EXTEND communication parameter configuration:

Item	content
SH-300 COM port	9 pin COM port
Default parameter (RTU)	Consistent with PLC Port
Default parameter (ASCII)	Consistent with PLC Port
Station No.	1-247, 1 is windows default
Protocol	MODBUS RTU/ASCII, RTU/ASCII EXTEND
Distance (Max.)	15m/100m (twisted-pair)
Communication mode	RS232/485/422
Cable type	MODBUS-RS232/485/422
Coil variable address type	0X
Discrete variable address type	1X
Register variable address type	3X/4X/5X/6X

### 3. Connection guidance of Special cable

#### MODBUS-RS232

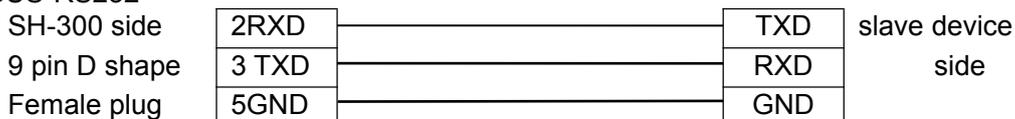

#### MODBUS-RS485

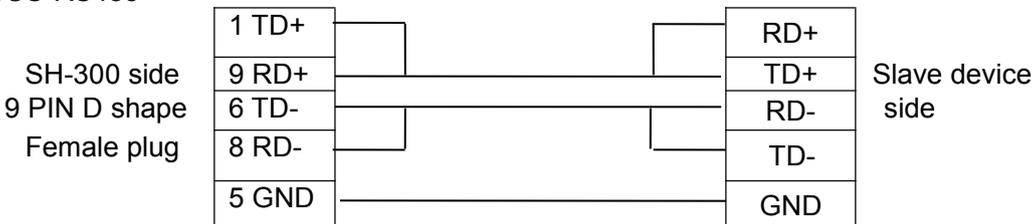

#### MODBUS-RS422

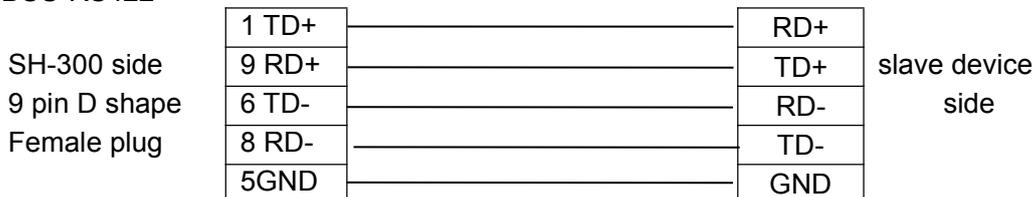

**4. The list of corresponding relationship between address type of SH-300 and function codes in Modbus RTU/ASCII Protocol**

Object type	Address type	Function code	R/W	Description
Indicator	0x	0x01	Read	Read coils ON/OFF status
	1x	0x02	Read	Read discrete input
Function Key	0x	0x05	Write	Write coils ON/OFF status
Dynamic text	3x	0x04	Read	Read input register
	4x	0x03	Read	Read holding register
Register	3x	0x04	Read	Read input register
	4x	0x03	Read	Read holding register
		0x06	Write	Write single holding register
		0x10	Write	Write double holding register
Bar graph/ Trend graph	3x	0x04	Read	Read input register
	4x	0x03	Read	Read holding register

**5. The list of corresponding relationship between address type of SH-300 and function codes in Modbus RTU/ASCII EXTEND Protocol**

Object type	Address type	Function code	R/W	Description
Indicator	0x	0x01	Read	Read coils ON/OFF status
	1x	0x02	Read	Read discrete input
	3x_bit	0x04	Read	Read one bit of input register value
	4x_bit	0x03	Read	Read one bit of holding register value
Function Key	0x	0x05	Write	Write coils ON/OFF status
	4x_bit	0x06	Write	Write one bit of single holding register value
		0x10	Write	Write one bit of double holding register
Dynamic text	3x	0x04	Read	Read input register
	4x	0x03	Read	Read holding register
	5x			
	6x			
Register	3x	0x04	Read	Read input register
	4x	0x03	Read	Read holding register
		0x06	Write	Write single holding register
		0x10	Write	Write double holding register
	5x	0x03	Read	Read holding register
		0x06	Write	Write single holding register
		0x10	Write	Write double holding register
	6x	0x03	Read	Read holding register
0x06		Write	Write single holding register	
Bar graph/ Trend graph	3x	0x04	Read	Read input register
	4x	0x03	Read	Read holding register
	5x			
	6x			

Note:

1. When selecting "3x" as register address type, single or double register only can be read, not to be written.
2. When selecting "4x" as register address type to read or write double register. **the first byte contains the high order bit and the second contains the low order bit.**
3. When selecting "5x" as register address type to read or write double register. **The first byte contains the low order bit and the second contains the high order bit.**
4. When selecting "6x" as register address type, only single register can be read or written
5. "bit" expresses the bit address of Register value. It is in the range of "0~F". The register value is expressed as the data of sixteen bit binary. Each bit expresses one coil status. Status is indicated as: 1 = ON, 0 = OFF.
6. when selecting "4x\_bit" as address type of function key , one bit of register value can be set "0" or "1". (single or double Register).

**6. Parameter setting in the SH-300 software**

6.1 Consult PLC user manual about setting communication port parameter in Modbus protocol. Click "Set plc type" under "Connect" option, and set the SH-300 communication parameter. In order to communicate with the PLC normally, the communication parameter of SH-300 must be consistent with that of PLC.

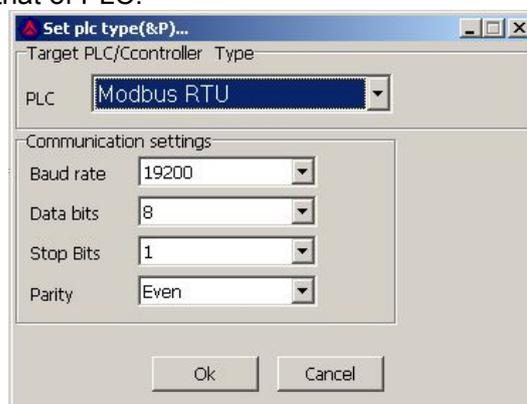

6.2 Consult PLC user manual and work out the data address accurately. Different type PLC uses different method of calculating data address. The following examples will introduce the operation of some coils and registers with SH-300 software in MODBUS protocol.

6.2.1 Here is an example of setting coil M15 status

Use the function key " " to set coil M15 status. According to "the list of corresponding relationship between address type and function codes in Modbus Protocol" the address type of setting coil status is "0X". Inner coil(M) address is in the range of M0-M512(D). MODBUS data address is in the range of 3072-3583. The corresponding MODBUS data address of M15 is 3087.

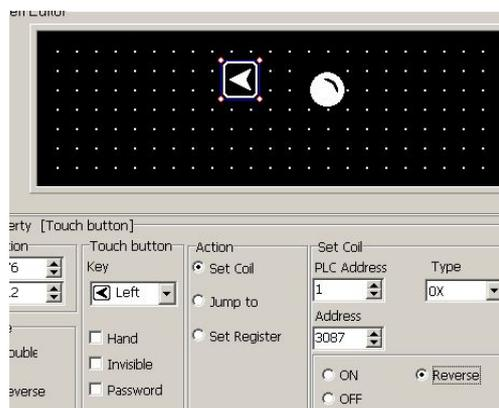

When SH-300 set coil 15 the data format to be send from SH-300 is shown as following.

Query message	
Field Name	Example (Hex)
Device address	-
Function code	05
Coil address Hi	0C
Coil address Lo	0F
Set data Hi	FF
Set data Lo	00
CRC Lo	-
CRC Hi	-

The query message specifies the coil to be set. The requested ON/OFF state is specified by a constant in the query data field. A value of FF 00 hex requests the coil to be ON. A value of 00 00 requests it to be OFF. All other values are illegal and will not affect the coil.

Response: The normal response is an echo of the query, returned after the coil state has been set.

6.2.2 Here is an example of reading coils M15

Use indicator "☐" to indicate coil M15 status. According to "the list of corresponding relationship between address type and Function Codes in Modbus Protocol" the address type of reading coil status is "0X". The corresponding MODBUS data address of M15 is 3087.

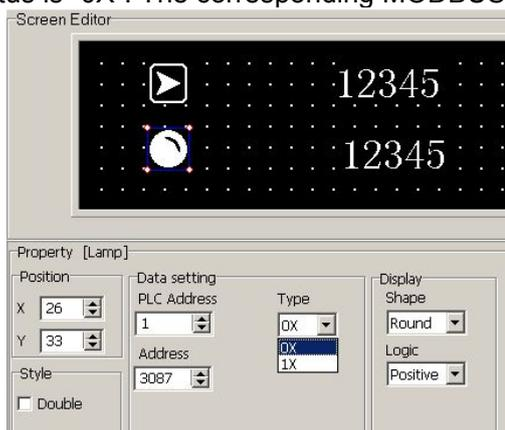

When SH-300 read coil M15 the data format to send from SH-300 and responded by PLC is shown as following.

Query message	
Field Name	Example (Hex)
Device address	-
Function code	01
Coil starting address Hi	0C
Coil starting address Lo	0F
No. of Coil Hi	00
No. of Coil Lo	01
CRC Lo	-
CRC Hi	-

response message	
Field Name	Example (Hex)
Device address	-
Function code	01
The count of return bytes	01
Data (Coil M22-M15)	-
CRC Lo	-
CRC Hi	-

The coil status in the response message is packed as one coil per bit of the data field. Status is indicated as: 1 = ON; 0 = OFF. The LSB of the data byte contains coil M15 addressed in the query. The highest order end of this byte contains coil M22.

"1X" expresses reading discrete input .For example PLC input signal, inner special coil status etc.



6.2.3. Here is an example of displaying and setting Register R1088

According to “the list of corresponding relationship between the address type and function codes in Modbus Protocol” the address type of reading and writing holding register is “4X” ,The holding register address is in the range of R0-R3839. Modbus address is in the range of 0-3839. the corresponding Modbus data address of register R1088 is 1088.

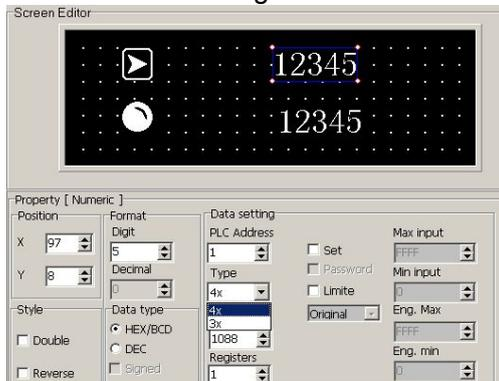

When SH-300 read holding register the data format to be send from SH-300 and responded by PLC is shown as following.

Query message	
Field Name	Example(Hex)
Device address	-
Function code	04
Register starting address Hi	04
Register starting address Lo	40
No. of registers Hi	00
No. of registers Lo	01
CRC Lo	-
CRC Hi	-

Response message	
Field Name	Example(Hex)
Device address	-
Function code	04
The count of return bytes	02
Data Hi (Register R1088)	-
Data Lo (Register R1088)	-
CRC Lo	-
CRC Hi	-

When SH-300 write holding register the data format to be send from SH-300 is shown as following.

Query message	
Field Name	Example (Hex)
Device address	11
Function code	06
Register address Hi	00
Register address Lo	01
Set data Hi	00
Set data Lo	03
CRC Lo	-
CRC Hi	-

Response :The normal response is an echo of the query, returned after the register contents have been written.

Note:

1. If the communication parameter is not correct. SH-300 will not communicate with PLC normally.
2. If the data address you input is not in the range that is specified by user manual. SH-300 will not communicate with PLC normally.
3. If PLC don't support the address type you select (For example Delta PLC don't support "3X"). SH-300 will not communicate with PLC normally.

## 4.17 SH-300 Freedom Protocol

### 1. Communication configuration

SH-300 can communicate with some controllers via freedom protocol. When SH-300 communicates with controller via this protocol user need to define own controller freedom communication format first. Here SH-300 is a master, controller is a slave. The request message is sent from SH-300 and controller makes response message. Communication parameter is shown as following:



Item	Content
SH-300 COM port	9 pin COM port
Controller COM port	Programming port
Default parameter	9600bps、8bits、1stop、None
Station No.	1-254 ,1 is Windows default
Distance (Max.)	15m/100m (twisted-pair)
Communication mode	RS232/485/422
Cable type	FREE-RS232/FREE-RS485/FREE-422

The freedom communication protocol takes byte as least addressing unit. And the most addressing is in the range of 0-FFFFFFFF. The value of Register is stored with byte value. For each Register, the first byte contains the high order bits and the second byte contains the low order bits. Simultaneously one byte can be expressed as an eight-bit binary value which shows each status of the 8 coils respectively. For example the Register B0 contains eight coil address(M0-M7). That's to say if you change the status of coil M0 up to M7. the value of Register has been changed too. and if you change the value of Register ,the status of coil M have been changed too. Therefore when you use this protocol you need to distribute the address between Register and coil.

If Registers are addressed starting at B0, W0, DW0. Allocation map of memory address is shown as following:

Register address	Double word	DW0				DW4				.....
	word	W0		W2		W4		W6		.....
	byte	B0	B1	B2	B3	B4	B5	B6	B7	.....
Coil address		M0	M8	M16	M24	M32	M40	M48	M56	.....
		M7	M15	M23	M31	M39	M47	M55	M63	.....

If Registers are addressed starting at B1, W1,DW1. Allocation map of memory address is shown as following:

Register address	Double word	DW1				DW3				.....
	word	W1		W3		W5		W7		.....
	byte	B1	B2	B3	B4	B5	B6	B7	B8	.....
Coil address		M8	M16	M24	M32	M40	M48	M56	M64	.....
		M15	M23	M31	M39	M47	M55	M63	M71	.....

Example: Write the double word values of 075BCD15 into Register DW0, the value of per byte is distributed as following:

The address of double word	DW0			
The address of word	W2		W0	
The address of byte	B 3	B2	B1	B0
set value	07	5B	CD	15

The value of DW0 is 075BCD15 when Register is addressed as double word. The value of W0 is CD15, W2 is 075B when Register is addressed as word. The value of B0 is 15, B1 is CD, B2 is 5B, B3 is 07 when Register is addressed as byte.

## 2. Connection guidance of special cable

### FREE-RS232

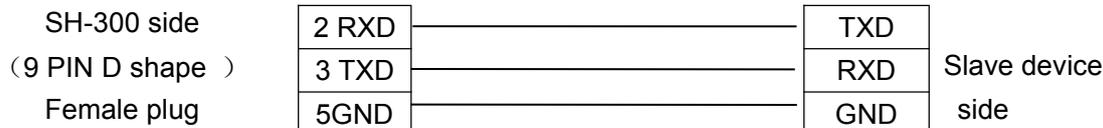

### FREE-RS485

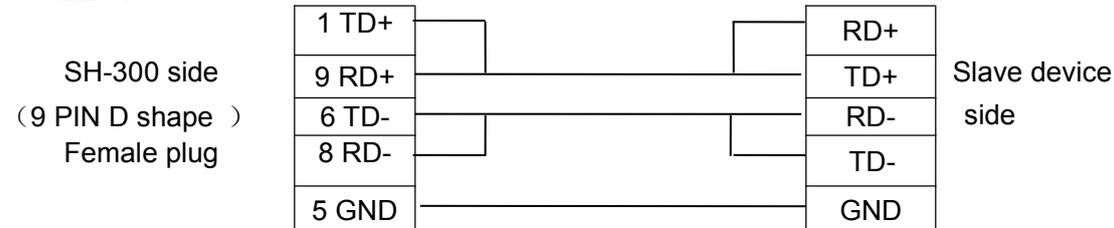

### FREE-RS422

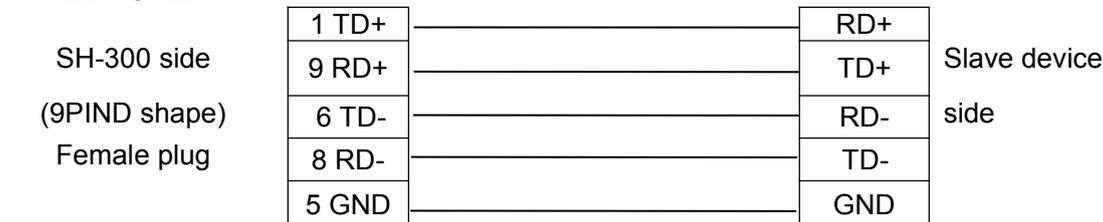

### 3. The data format of query from SH-300 and response from PLC

When SH-300 communicates with controller via freedom protocol the Register data and the status of inner coils can be set up by SH-300 and displayed on the SH-300 at real time. PC can be taken as dummy controller to communicate with SH-300. Here PC displays not only the Register data and the status of inner coils but also the data PC receives and sends during communicating with SH-300. In order to validate the communication between SH-300 and PC in time. Take the communication between SH-300 and PC as an example to introduce the data format of query from SH-300 and response from controller in freedom communication protocol.

#### 1. Read single Coil Status M (0x40)

Use this function code to read the status of single coil in controller. The query message specifies coil address. Coil status is indicated as: 01 = ON; 00 = OFF in the response message

Here is an example of reading the status coil M25 (0X40)

- a. Make the screen displayed as following, use function key  to set the status of coil M25

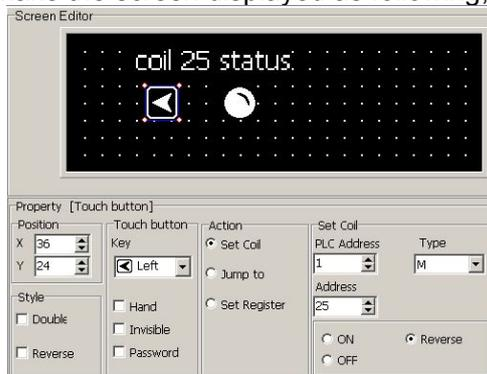

- b. Connect SH-300 with PC by using a SH-PC cable, download the screen into SH-300

- c. click  to enter simulation state, use indicator to indicate the coil status

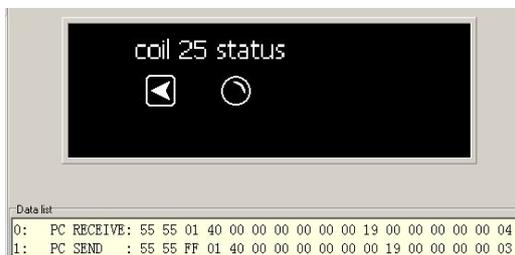
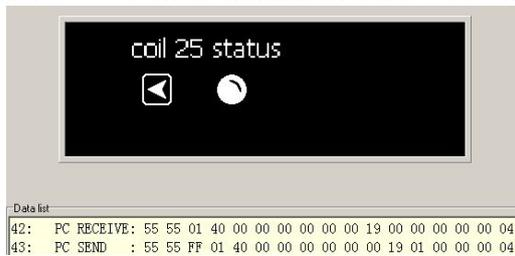

When reading coil M25 status the data format of query message from SH-300 and response message from controller is shown as following:

Byte NO.	Query format (controller receive)	Example	Response format (controller send)	Example
0	Framing starting	55	Framing starting	55
1	Framing starting	55	Framing starting	55
2	Device address	01	Response status	FF
3	Function code	40	Device address	01
4	Address offset	00	The function code	40
5	Reserved byte	00	Addressing offset	00
6	Reserved byte	00	Reserved byte	00
7	Address high order bit (Hi byte)	00	Reserved byte	00
8	Address high order bit (Lo byte)	00	Address high order bit (Hi byte)	00
9	Address Low order bit (Hi byte)	00	Address high order bit (Lo byte)	00
10	Address Low order bit (Lo byte)	19	Address Low order bit (Hi byte)	00
11	Reserved byte	00	Address Low order bit (Lo byte)	19
12	Reserved byte	00	The status message of one coil	01/00
13	Reserved byte	00	Reserved byte	00
14	Reserved byte	00	Reserved byte	00
15	Reserved byte	00	Reserved byte	00
16	Verify value	04	Verify value	04/03

#### Description :

The value of Register and coil address is stored as byte value. According to the value of the address first use address Low order bit, and then use address high order bit. For each address bit , The first byte contains the high order bits and the second byte contains the low order bits.

The framing of query and response message contains seventeen bytes which is fixed .

Framing starting [55][55] :the value is fixed.

Addressing offset [00]: If coils M0 is addressed as 0 the address offset is [00], If coils M1 is addressed as 0 the address offset is [01],

Response status: 0x00 expresses error ,0xFF expresses right

Address low order bit: [00][19] expresses that the address of the coil to be read is 25 (D).

The response state [FF] expresses normal response, [00] expresses abnormal response.

Verify value: plus all bytes from framing starting byte to the penultimate byte, take the last byte of the summation as verify value.

#### 2. Write Single Coil M (0x41)

Use this function code to setup ON/OFF state of single coil in controller

The ON/OFF state of requested coil is specified by a constant in the query data field. A value of FF 00 hex requests the coil to be ON. A value of 00 00 requests it to be OFF. Any other values are illegal and will not affect the coil.

Here is an example of writing coil M25

use function key  to set the coil status and use indicator to indicate it.

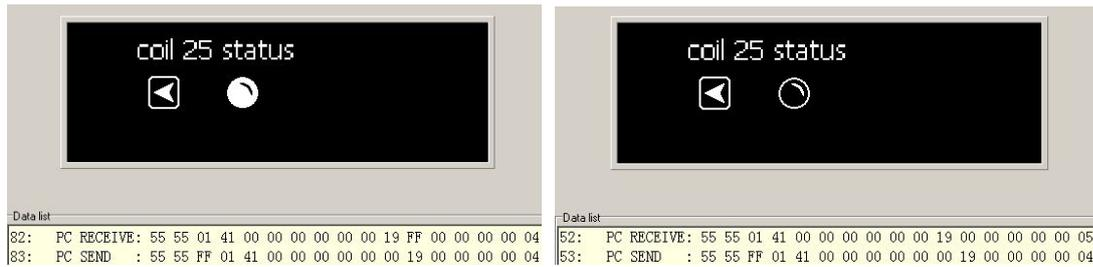

When writing coil M25 status the data format of query message from SH-300 and response message from controller is shown as following:

Byte NO.	Query format (controller receive)	Example	Response format (controller send)	Example
0	Framing starting	55	Framing starting	55
1	Framing starting	55	Framing starting	55
2	Device address	01	Response status	FF
3	Function code	41	Device address	01
4	Address offset	00	Function code	41
5	Reserved byte	00	Address offset	00
6	Reserved byte	00	Reserved byte	00
7	Address high order bit (Hi)	00	Reserved byte	00
8	Address high order bit (Lo)	00	Address high order bit (Hi)	00
9	Address Low order bit (Hi)	00	Address high order bit (Lo)	00
10	Address Low order bit (Lo)	00	Address Low order bit (Hi )	00
11	Coil status value . 0xFF express M ON, 0x00 express M OFF .	FF/00	Address Low order bit (Lo)	19
12	Reserved byte	00	Reserved byte	00
13	Reserved byte	00	Reserved byte	00
14	Reserved byte	00	Reserved byte	00
15	Reserved byte	00	Reserved byte	00
16	Verify value	04/05	Verify value	04

3. Read single byte of Register B (0X42)

Use this function code to read the value of single byte of Register in controller. The query message specifies the Register address. Registers are addressed starting at zero: Register 0 is addressed as 0.

4. Write single byte of Register B (0X43)

Use this function code to write the value into the single byte of Register in controller .The query message specifies the Register address and the value of single byte to be written. Registers are addressed starting at zero: Register 0 is addressed as 0

5. Read single Register W (0X44)

Use this function code to read the value of single Register in controller. The query message specifies the Register address. Registers are addressed starting at zero: Register 0 is addressed as 0. the Register data in the response message occupy two byte. the first byte contains the high order bits and the second byte contains the low order bits.

6. Write single Register W (0X45)

Use this function code to write the value into single Register in controller .The query message specifies the Register address and the value of single Register to be written. Registers are addressed starting at zero: Register 0 is addressed as 0

7. Read double Register DW (0X46)

Use this function code to read the value of double Registers in controller. The query message specifies the Register starting address. Registers are addressed starting at zero: Register 0 is addressed as 0. Each Register data in the response message occupy two byte. The first byte contains the high order bits and the second contains the low order bits.

Here is an example reading the value of Register 35 36

a. Make the screen displayed as the following:

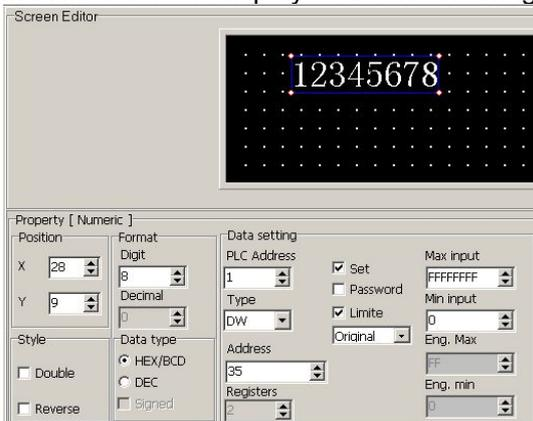

- b. Connect SH-300 with PC, download the screen into SH-300
- c. Click "▶" to enter into simulation mode. Display the set value of Register 35 36.

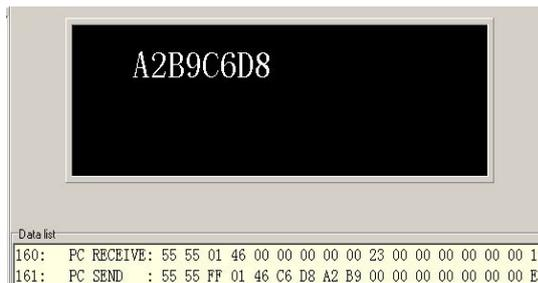

When reading Register 35 36 the data format of query message from SH-300 and response message from controller is shown as following:

Byte NO.	Query format (controller receive)	Example	Response format (controller send)	Example
0	Framing starting	55	Framing starting	55
1	Framing starting	55	Framing starting	55
2	Device address	01	Response status	FF
3	Function code	46	Device address	01
4	Reserved byte	00	Function code	46
5	Reserved byte	00	Register 35 data Hi	C6
6	Address high order bit (Hi)	00	Register 35 data Lo	D8
7	Address high order bit (Lo)	00	Register 36 data Hi	A2
8	Address Low order bit (Hi)	00	Register 36 data Lo	B9
9	Address Low order bit (Lo)	23	Reserved byte	00
10	Reserved byte	00	Reserved byte	00
11	Reserved byte	00	Reserved byte	00
12	Reserved byte	00	Reserved byte	00
13	Reserved byte	00	Reserved byte	00
14	Reserved byte	00	Reserved byte	00
15	Reserved byte	00	Reserved byte	00
16	Verify value	14	Verify value	E9

8. Write double Register DW (0X47)

Use this function code to write the value into two continuous Register in controller .The query message specifies the Register starting address and the data of double Register to be written. Registers are addressed starting at zero: register 0 are addressed as 0.

Here is an example of writing 2A6B8C9D hex into two Registers 58.59 in controller

a. Make the screen displayed as the following:

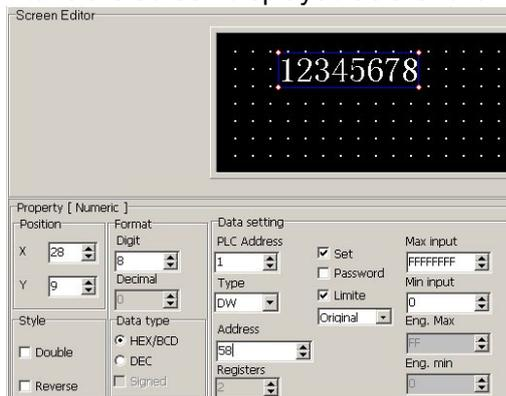

b. Connect SH-300 with PC, download the screen into SH-300.

c. click "▶" enter into simulation mode write 2A6B8C9D hex into two registers 58.59

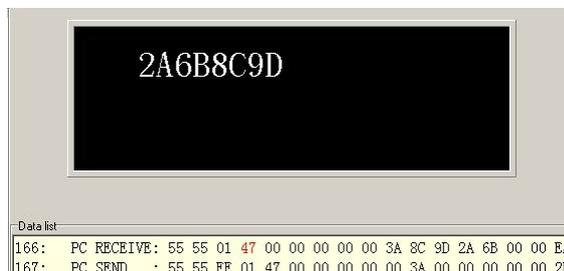

When write 2A6B8C9D hex into two Registers 58 59 in controller the data format of query message from SH-300 and response message from controller is shown as following:

Byte NO.	Query format (controller receive)	Example	Response format (controller send)	Example
0	Framing starting	55	Framing starting	55
1	Framing starting	55	Framing starting	55
2	Device address	01	Response status	FF
3	Function code	47	Device address	01
4	Reserved byte	00	Function code	47
5	Reserved byte	00	Reserved byte	00
6	Address high order bit (Hi)	00	Reserved byte	00
7	Address high order bit (Lo)	00	Address high order bit (Hi)	00
8	Address Low order bit (Hi)	00	Address high order bit (Lo)	00
9	Address Low order bit (Lo )	3A	Address Low order bit (Hi)	00
10	Register 58 data Hi	8C	Address Low order bit (Lo)	3A
11	Register 58 data Lo	9D	Reserved byte	00
12	Register 59 data Hi	2A	Reserved byte	00
13	Register 59 data Lo	6B	Reserved byte	00
14	Reserved byte	00	Reserved byte	00
15	Reserved byte	00	Reserved byte	00
16	Verify value	EA	Verify value	2B

9. Read a series of coils M (0X48)

Use this function code to read a series of coil status in controller. The query message specifies coil starting address .The quantity of coil status byte depends on the quantity of the coil to be read and the coil starting address,  $N=(\text{the coil number} + \text{the coil starting address})/8$  if the remainder is unequal to zero  $N=N+1$ , Coil status [Data 1]..... [Data N]: each bit of byte indicate one coil status .In which bit of which byte the coil M status information is depends on the starting address of M and the quantity of the coils to be read. The address of M is octal. If the returned coil quantity is not a multiple of eight, the remaining bits in the final data byte will be padded with zeros (toward the high order end of the byte).



Here is an example of reading alarm list coil M1-M8 status (M0 is the lowest coil)

- a. Make the alarm list displayed as the following:
- b. Use function key to set coil M1.M2.M3.M8 ON and others OFF.

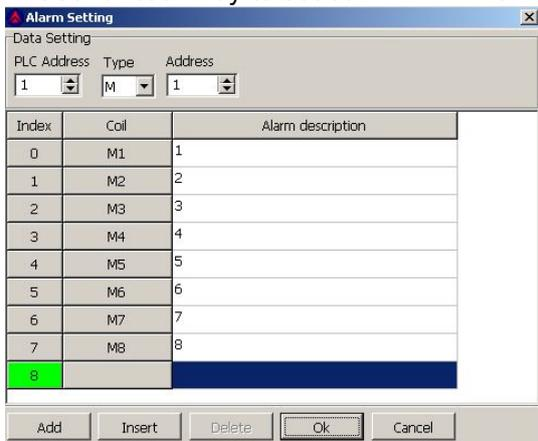

- c. Connect SH-300 with PC
- d. Click "▶" enter into simulation mode



Description: The status messages of coil M1-M8: [0E][01]

Coil No.	M7	M6	M5	M4	M3	M2	M1	M0
Coil status	0	0	0	0	1	1	1	0
data	0				E			

Coil No.								M8
Coil status	0	0	0	0	0	0	0	1
data	0				1			

When read coil M1-M8 status in controller the data format of query message from SH-300 and response message from controller is shown as following:

Byte NO.	Query format (controller receive)	Example	Response format (controller send)	Example
0	Framing starting	55	Framing starting	55
1	Framing starting	55	Framing starting	55
2	Device address	01	Response status	FF
3	Function code	48	Device address	01
4	Address offset	00	Function code	48
5	Reserved byte	00	Address offset	00
6	Reserved byte	00	Reserved byte	00
7	Address high order bit (Hi)	00	Reserved byte	00
8	Address high order bit (Lo)	00	Address high order bit (Hi)	00
9	Address Low order bit (Hi)	00	Address high order bit (Lo)	00
10	Address Low order bit (Lo)	01	Address Low order bit (Hi)	00
11	The quantity of the coil to be read	08	Address Low order bit (Lo)	01
12	Reserved byte	00	The byte count occupied by coil status	02
13	Reserved byte	00	Coil status [data 1]	0E
14	Reserved byte	00	Coil status [data N]	01
15	Reserved byte	00	Verify value	04
16	Verify value	FC		

## 4.18 Array FAB Series PLC

SH-300 can communicate with Array FAB series PLC, and the communication port is the programming port of PLC.

SH-300 software configuration:

Item	Content
SH-300 COM port	9 pin COM port
PLC COM port	Programming port
Default parameter	9600bps、8bits、1stop、none
Station No.	0-254, default value: 0
Distance (Max.)	15m
Communication mode	RS232
Cable type	AF-C232/AF-D232

Explanation: The station number of SH-300 must be the same one as the current address value in FAB communication configuration, or the SH-300 can not communicate with FAB normally.

The description of address types used in SH300 software:

Object type	Address type	Address range	Read/Write	Description
Indicator	I	1~12	Read	Read input status
	Q	1~8	Read	Read output status
	M	The number of the corresponding auxiliary relays in FAB program: (0~127)	Read	Read the output status of the function block in FAB program.
Function key	Q	1~8	Write	Write the status of empty output port (the output port that is not programmed in FAB program.)
Dynamic text	I	1~12	Read	Read input analog value (DC type PLC)
	B	The number of the corresponding function block in SR program: (0~127)	Read	Read the parameter value of the function block in FAB program.
Register	I	1~12	Read	Read input analog value
	B	The number of the corresponding function block in SR program: (0~127)	Read	Read the parameter value of the function block in FAB program.
			Write	Read the parameter value of the function block in FAB program.
B	The number of the corresponding function block in SR program	Read	Read the parameter value of the function block in FAB program.	

Example 1: As the following FAB program shows, SH-300 can display the status of I1~I6, Q1~Q4, and can control the ON/OFF status of Q2, Q3, Q4 through the function key, and can read/write the function blocks B2, B3 as well.

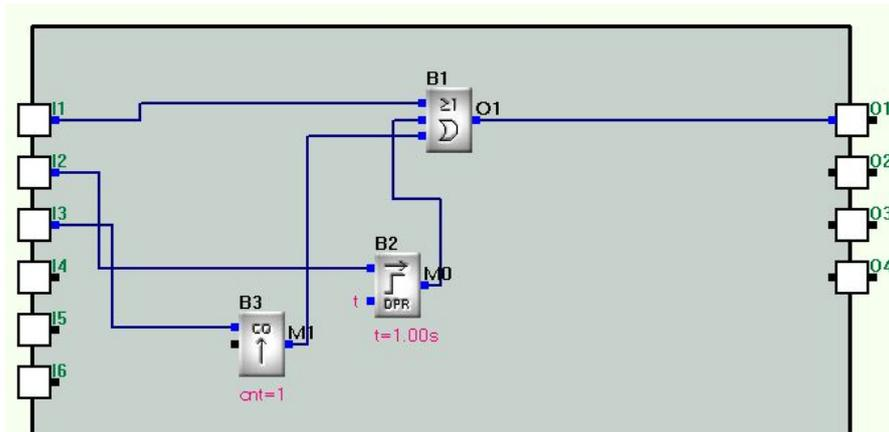

Example 2: The operation of reading the input/output and the output status of the function block in FAB program.

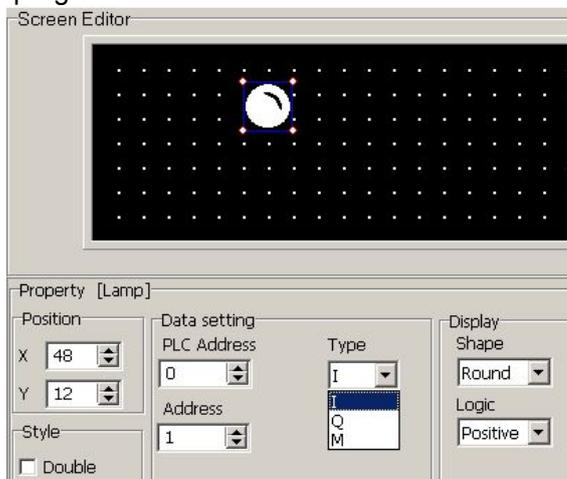

Example3: The operation of writing the status of output port (Only the empty port is writable.)

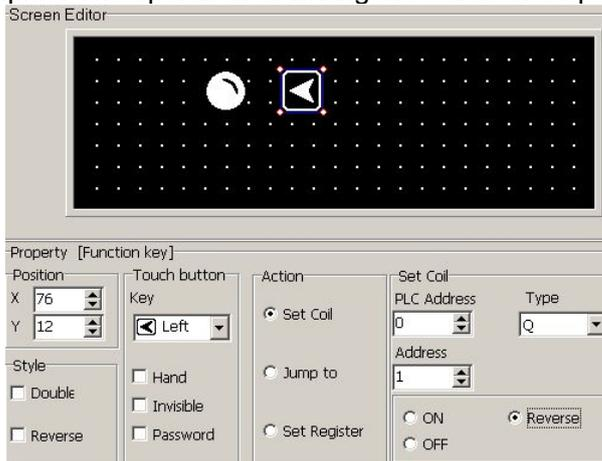

Example4: Read the analog value and the parameter of the function block in FAB program.

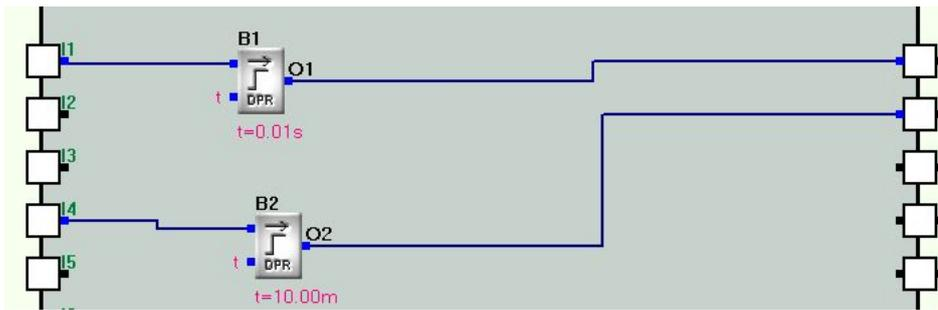

FAB program is shown above. If there is a need to set and display the value of the function block B1 through SH-300, the operation is shown as following graph:

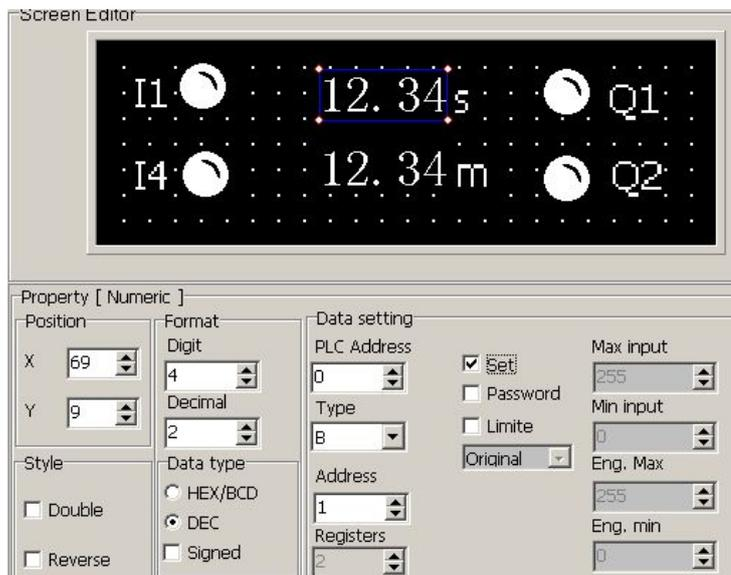

Explanation: As the SH-300 can not identify second, minute and hour when it is displaying and setting the time of function block, the static text can be used firstly to input the unit that needs to be displayed (e.g. s m h). When SH-300 is setting the time parameter, the fixed format is used: digits: 4, decimal digits: 2, in order to keep the same format as it displayed in FAB program. And when it is setting the analog parameter, the fixed format is used: digits: 3, decimal digits: 1.

## 4.19 Array SR Series PLC

SH-300 can communicate with Array SR series PLC, and the communication port is the programming port of PLC.

SH-300 software configuration:

Item	Content
SH-300 COM port	9 pin COM port
PLC COM port	Programming port
Default parameter	38400bps、8bits、1stop、none
Distance (Max.)	15m
Communication mode	RS232
Cable type	SR-CP

The description of address types used in SH300 software:

Object type	Address type	Address range	Read/Write	Description
Indicator	I	IA0~IA7 0.0~0.7 IB0~IB7 1.0~1.7 IC0~IC7 2.0~2.7 ID0~ID7 3.0~3.7 etc.	Read	Read the input status.
	Q	QA0~QA7 0.0~0.7 QB0~QB7 1.0~1.7 QC0~QC7 2.0~2.7 QD0~QD7 3.0~3.7 etc.	Read	Read the output status.
	M	The number of the corresponding auxiliary relays in SR program: (0~127)	Read	Read the output status of the function block in SR program.
Register	ON Delay TOND	The number of the corresponding function block in SR program: (0~127)	Read/Write	Select "Property Parameter" to set the time for function block.
	OFF Delay TOFD	The number of the corresponding function block in SR program: (0~127)	Read/Write	Select "Property Parameter" to set the time for function block.
	Single pulse generator PONS	The number of the corresponding function block in SR program: (0~127)	Read/Write	Select "Property Parameter" to set the time for function block.
	Clock pulse generator BLNK	The number of the corresponding function block in SR program: (0~127)	Read/Write	Select "Property Parameter" to set the time for function block.
	Holding-ON-delay relay MTOD	The number of the corresponding function block in SR program: (0~127)	Read/Write	Select "Property Parameter" to set the time for function block.

	UP/DOWN Counter UDCT	The number of the corresponding function block in SR program: (0~127)	Read/Write	Select "Property Parameter" to set count value for function block.
	analog comparator CMPR	The number of the corresponding function block in SR program: (0~127)	Read/Write	Select "Property Parameter" to set comparison value for function block.
	Input analog IN	0~7	Read	Read analog input value
Garph bar	ON Delay TOND	The number of the corresponding function block in SR program: (0~127)	Read (*2)	Display the current value of function block.
	OFF Delay TOFD	The number of the corresponding function block in SR program: (0~127)	Read (*2)	Display the current value of function block.
	Single pulse generator PONS	The number of the corresponding function block in SR program: (0~127)	Read (*2)	Display the current value of function block.
	Clock pulse generator BLNK	The number of the corresponding function block in SR program: (0~127)	Read (*2)	Display the current value of function block.
	Holding-ON-delay relay MTOD	The number of the corresponding function block in SR program: (0~127)	Read (*2)	Display the current value of function block.
	UP/DOWN Counter UDCT	The number of the corresponding function block in SR program: (0~127)	Read (*2)	Display the current value of function block.
	analog comparator CMPR	The number of the corresponding function block in SR program: (0~127)	Read (*2)	Display the current value of function block.
	Input analog IN	0~7	Read (*2)	Display analog input value
Dynamic text	UP/DOWN Counter UDCT	The number of the corresponding function block in SR program: (0~127)	Read	Display the dynamic text corresponding to count value.

Note: \*1 The text panel displays the time in the format of hour: minute: second-millisecond. If the displayed time exceeds 1 hour, the millisecond will not be displayed.

\*2 when the current value of TOND TOFD PONS BLNK MTOD function block is displayed by graph bar ,the min and max limit of register = the current value \*100  
 when the analog input value is displayed by graph bar ,the min and max limit of register = the analog value \*10

## 4.20 Array APB Series PLC

SH-300 can communicate with ARRAY APB series PLC, and the communication port is PLC programming port.

SH-300 Software Configuration:

Item	Content
SH-300 COM port	9 pin COM port
PLC COM port	Programming port
Default parameter	9600bps、8bits、1stop、none
Communication distance(Max.)	15m
Communication mode	RS232
Cable type	APB-CP

The description of address types used in SH300 software:

No.	Object type	Address type	Address range	Read/Write	Description
1	Indicator/ Message display	I	I0~ID ... I70~I7D	Read	Read input status
		Q	Q0~Q7 ... Q70~Q77	Read	Read output status
		M	M0~M1999	Read	Read the output status of the intermediate relay in APB program.
2	Dynamic text/ Bar graph/ Trend Graph	AI	AI0~AI15	Read	Read analog input value
		AQ	AI0~AI15		Read analog output value
		AM	AM0~AM63		Read analog middle variable value
		DW	DW0~DW255		Read register value
		BR	BR0.0~n~BR31 9.0~n		Read the parameter value of the function block in APB program. 0 indicates reading the running value of the function block; 1 indicates reading the first set parameter value of the function block; 2 indicates reading the second set parameter value of the function block; n indicates reading the nth set parameter value of the function block;
3	Register	AI	AI0~AI15	Read	Read analog input value
		AQ	AI0~AI15	Read/Write	Read/Write analog output value
		AM	AM0~AM63	Read/Write	Read/Write analog variable value
		DW	DW0~DW255	Read/Write	Read/Write register value
		BR	BR0.0~n~BR31 9.0~n	Read/	Read/Write the parameter value of the function block in APB program.

				Write	0 indicates the running value of the function block; 1 indicates the first set parameter value of the function block; 2 indicates the second set parameter value of the function block; n indicates the nth set parameter value of the function block;
4	Timer	DW	DW0~DW255		Read register value
		BR	BR0.0~n~BR31 9.0~n		Read the parameter value of the function block in APB program. 0 indicates reading the running value of the function block; 1 indicates reading the first set parameter value of the function block; 2 indicates reading the second set parameter value of the function block; n indicates reading the nth set parameter value of the function block;

Note:

The block parameters have two types: ① register reference value ② constant value. When you modify the block parameters with SH-300, if the block parameters have different types, the types for selected registers will be different. If the register value is referenced, DW will be selected as the type for register to modify the block parameters. If the constant value is used, BR will be selected as the type for register to modify.

Example:

Use SH-300 to set parameter value of the function block BOO11, B0012, and read the running values of B0011 and B0012

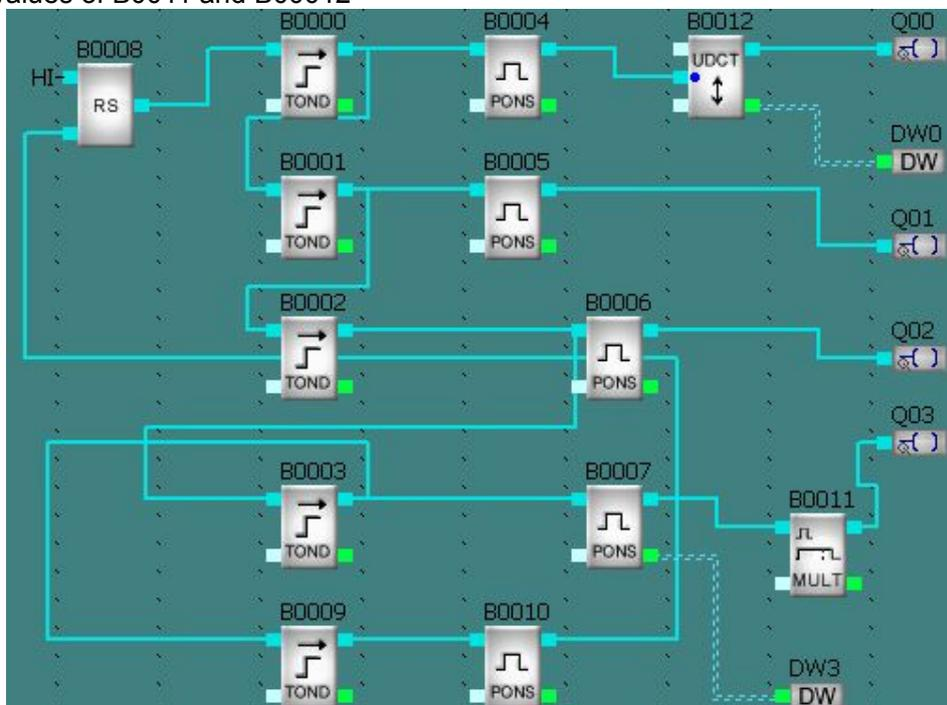

1. As B0011 is a function block of time type, **T** is selected as the function object. It is shown as following graph:
  - a. When reading the current value of function block, the address is BR11.0



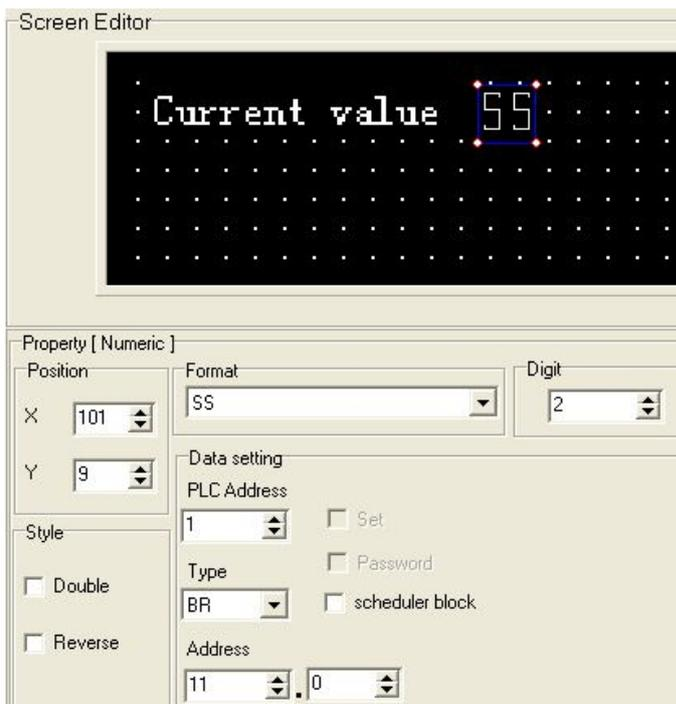

2. Modify the parameter value of function block B0011.

- a. In APB program, the value of the register DW10 is referenced as the off-delay time for the function block B0011, and the value of the register DW11 is referenced as the hold-ON time. The unit for the register value is millisecond.

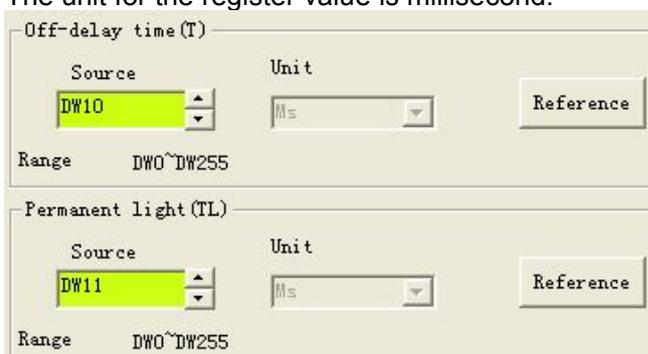

- b. Click **123** to set off-delay time for the function block B0011, and the address is DW10. The default unit for register value is Millisecond, which can be set as Second with 3 decimals.

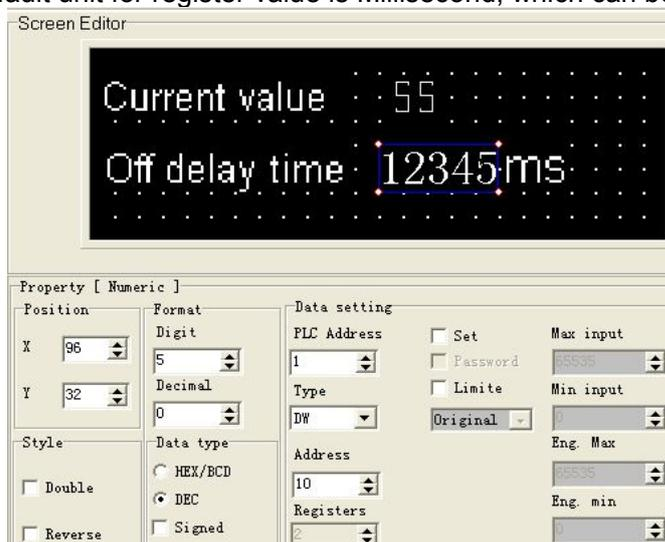

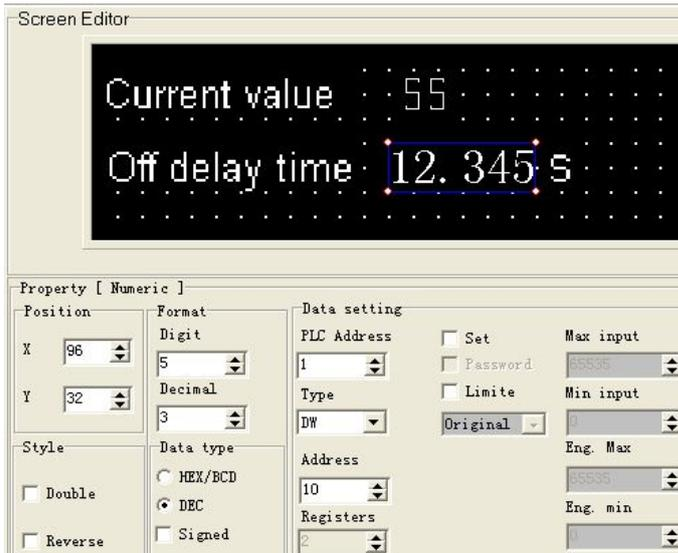

c. Click **123** to set permanent light time for the function block B0011, and the address is DW11. The default unit for register value is Millisecond, which can be set as Second with 3 decimals.

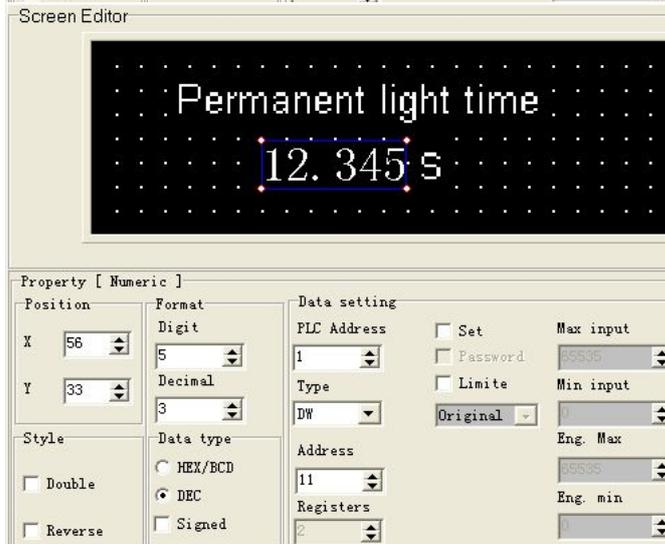
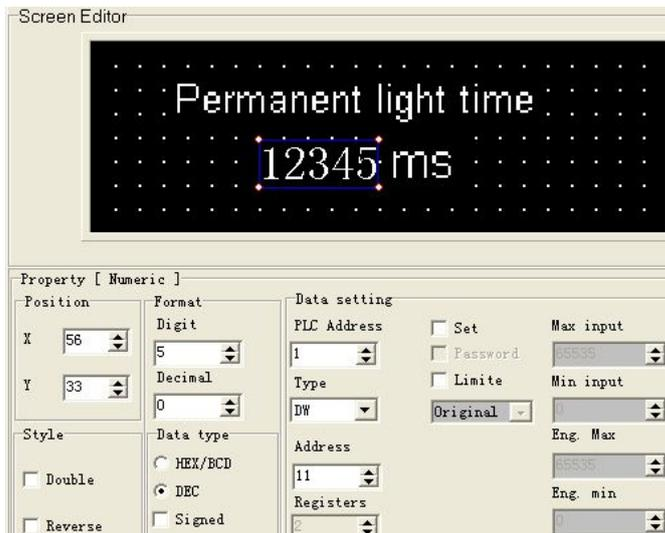

3. As B0012 is a function block of count type, 123 is selected as the function object to read the current value. It is shown as following graph:
  - a. Click 123 to read current value of the function block B0012, and the address is BR12.0.

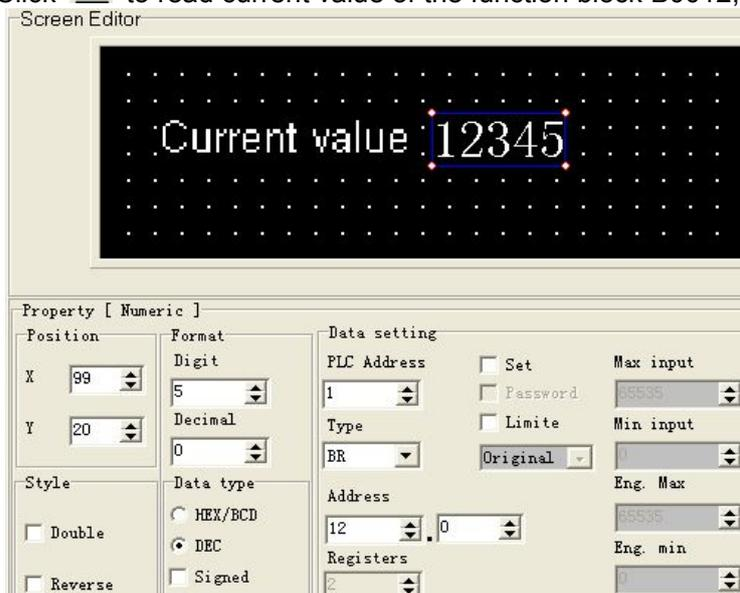

- b. In program, the property pin is connected with DW0 , the value of DW0 can be read by SH-300

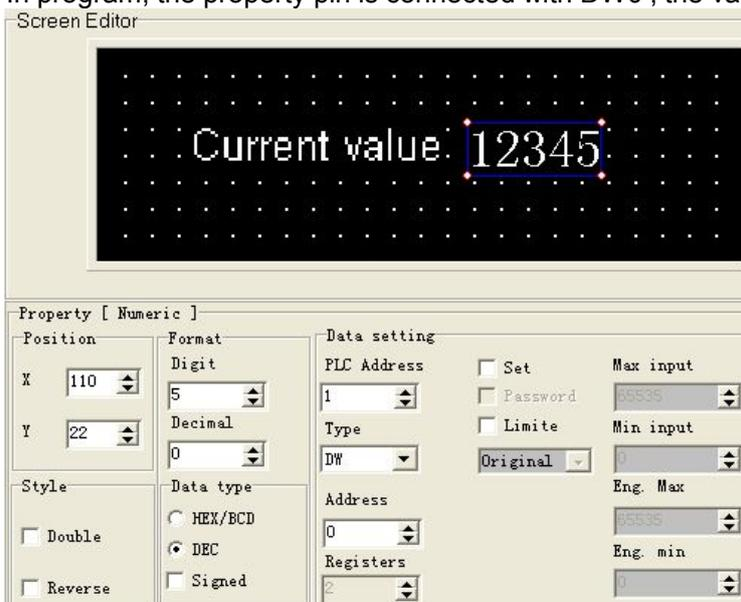

4. Modify parameter value of the function block B0012.
  - a. The value of the register DW12 is referenced as the count parameter for function block B0012 in APB program.

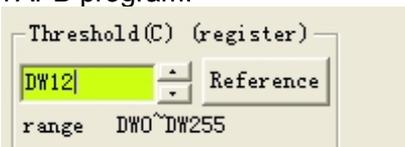

- b. Click 123 to set count parameter for the function block B0012, and the address is DW12.

Screen Editor

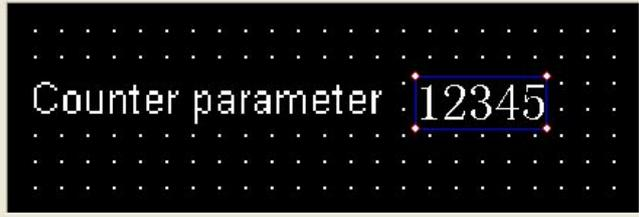

Property [ Numeric ]

Position		Format		Data setting			
X	124	Digit	5	PLC Address	<input checked="" type="checkbox"/> Set	Max input	
Y	22	Decimal	0	Type	<input type="checkbox"/> Password	Min input	5535
		Data type		DW	<input type="checkbox"/> Limite	Eng. Max	
		<input type="radio"/> HEX/BCD		Address	Original	Eng. min	0
<input type="checkbox"/> Double		<input checked="" type="radio"/> DEC		12			
<input type="checkbox"/> Reverse		<input type="checkbox"/> Signed		Registers			
				2			

## 4.21 Array TC-Pro Series Digital Timer/Counter/Tachometer

SH-300 can communicate with Array TC-Pro Series digital timer/counter/tachometer through communication port.

SH-300 software configuration:

Item	Content
SH-300 COM port	9 pin COM port
PLC COM port	Programming port
Default parameter	9600bps、7bits、1stop、Even
Station No.	0-254, default value: 0
Distance (Max.)	15m
Communication type	RS232
Cable type	CAB-090A232

The description of address types used in SH300 software:

Object type	Address type	Address range	Read/Write	Description
Indicator	M	Refer to address list for details	Read	Read reset signal and output status of timer/counter/tachometer
Register	D	Refer to address list for details	Read/Write	Read and write the register value of timer/counter/tachometer
Dynamic text	D	Refer to address list for details	Read	Read the register value of timer/counter/tachometer
Bar graph/ Trend graph	D	Refer to address list for details	Read	Read the register value of timer/counter/tachometer

Note: TC-Pro Series digital timer/counter/tachometer use Hex addresses. the register value is displayed in BCD.



## Appendix : Note item

- All basic default function keys except ALM, SET, ESC, ENT, UP, DOWN key can be redefined . If the default function conflict with the defined function, the basic function will be out of action.
- Setting register, press CLR key to enter desired digits. When only a single digit need to Change, move the cursor to the digit with the direction key and then input the number your need directly. If you want to input A-F in the Hex system, input 0 or 9 and press up/down key .
- If the actual digits of the register exceeds the maximum digits of the setting value the last digit entered is overwritten. So user must set the likely Max. value by the register type when programming.
- When jumping window of screen protection, pressing any key will be invalid and only returned to the original window.
- If the lower limit value of register, bar graph and trend line exceeds its upper limit value the program won't be downloaded and you will receive an incorrect report. Please check it before downloading the program
- When set a new value of register use CLR key to delete the current set value and press the digital key to improve input speed.
- Under the precondition of reliable communication we should make the most of a higher baud rate. Higher baud rate can greatly improve the window refresh rate and decrease the response time for controlling button.